

 **ATLAS**
MATERIAL TESTING SOLUTIONS

An **AMETEK** Company



Network of Weathering
PRODUCTS & SERVICES

Experience. The Atlas Difference.

Table of Contents

About Atlas®

Corporate Overview..... 3

Complete Weathering Program..... 4

Light Quality

What Light is Right?..... 5

Xenon and Metal Halide

Filter Combination Charts..... 6-8

Ci Series Weather-Ometers..... 6

Xenotest® Instruments..... 7

Solar Simulation Chambers..... 7

SUNTEST® Family..... 8

Spectral Power Distribution Charts..... 9-10

Accelerated Weathering Products

Ci Series Weather-Ometers..... 11-14

Ci5000 Weather-Ometer®

Ci4000 Weather-Ometer

Ci3000+ Weather-Ometer

Ci3000+ Fade-Ometer®

Xenotest Instruments..... 15-18

Xenotest Beta+/Beta+ FD

Xenotest Alpha+

Xenotest 150 S+

Xenotest 220/220+

SUNTEST Family..... 19-22

XXL/XXL+

XLS+

CPS/CPS+

UVTest..... 23-24

Solar Simulation Chambers..... 25-26

SC340

SC600

SC1000

SC2000

Instrument Comparison Chart..... 27-30

Ci Series..... 27

Xenotest..... 28

SUNTEST..... 29

UVTest..... 29

Solar Simulation Chambers..... 30

Specimen Holders..... 31-32

Ci Series..... 31

Xenotest..... 32

SUNTEST..... 32

Custom Systems and KHS Technical Lighting.... 33-34

SolarConstant and High-Speed Lighting

Lab Corrosion Testing Equipment..... 35-38

SF — Traditional Salt Fog (Spray) and Humidity Cabinet

BCX — Basic Cyclic Corrosion Cabinet

CCX — Advanced Cyclic Corrosion Cabinet

Walk-in Corrosion Exposure Cabinet

Calibration and Measurement Devices..... 39

Technical Services

Technical Services..... 40



Natural and Accelerated Weathering

Benchmark Exposure Sites	41-42
Atlas® Worldwide Exposure Network	43
Laboratory Accelerated Weathering Services	44
Static Exposure Testing	45-46
Direct Weathering	45-46
Open-Backed Exposures	
Backed Exposures	
Black Box Exposures	
Scab Tests	
Indirect Weathering	46
Under Glass and Black Box Under Glass Exposures	
EMMAQUA®	47-51
Temperature and Moisture Controlled EMMAQUA	49-51
Static Temperature Control	
Dynamic Temperature Control	
Night Temperature Control	
Variable Irradiance Temperature Control	
Moisture Control	
Automotive Exposure Testing	52-54
IP/DP Box®	52
Weather Station	52
SAE J576 — Static Exposure	53
Complete Vehicle Testing	54
Special Measurements	
Sun Tracking Carousel	

Ultra-Accelerated Weathering System	55
Outdoor Exposure Rack System	55
Evaluation Services	56-58
Additional Services	59
Temperature Recording	59
Radiometer Measurement and Calibration	59
Mounting Techniques	60
Specimen Preparation and Mounting	60
Panels and Samples	60

Consulting Solutions

Consulting Solutions	61
----------------------------	----

Solar Industry Solutions

Solar Simulation Systems	61
Solar Test Center	62
Atlas 25+	63-64
Product/Service Index	65-66



A Global Leader in Weathering Testing Services and Technology

Since 1915 Atlas® has pioneered innovations in the way companies test the durability of their products. This catalog represents the breadth of our commitment to excellence in materials durability testing. From the advanced technology of our accelerated weathering equipment and services to the consultative services of our expert weathering scientists, our approach to the market is clear:

Provide our customers with sophisticated technology and advanced testing solutions to determine how long their products will last. As a result, they will reach their ultimate goals – *a quality product, a competitive edge, a faster time to market.*

Atlas Network of Weathering

No one understands your product better than you. Ensuring that your product performs to its maximum potential in its end-use environment is in the best interest to your brand, not to mention your bottom line.

But how do you know if your testing program is leading you down the road to better product performance and durability? Are you sure you are limiting liability issues? Will your product meet customer expectations?

The only way to answer these questions is to follow a scientifically designed weathering testing program. This includes proper design of experiment, subjecting your materials to a screening process, running accelerated and outdoor weathering tests and utilizing an independent 3rd party to validate the results. Employing these critical components gives you the “full picture” and a better prediction of how your product will perform in the marketplace.

Worldwide Technical Service

One of the benefits of working with the global leader in weathering is the availability of highly-trained, experienced technical service staff. Just about anywhere you are in the world, there is an Atlas technical services representative nearby.

The Atlas Mission

To help our customers worldwide provide the most reliable and durable product solutions through our NOW (Network of Weathering) that includes weathering instruments; aftermarket parts and consumables; worldwide technical support; natural and accelerated weathering sites offering indoor and outdoor testing services; custom lighting systems and consulting expertise.

A Complete Weathering Testing Program

Establishing a scientifically designed weathering testing program ensures you're getting the best look at product durability and performance. Implementing all five components is critical to obtaining the service life prediction you are looking to achieve. Our team of weathering experts works with you every step of the way to ensure your product has a bright future.

Design of Experiment

A scientifically designed weathering testing program helps you achieve the most accurate, reproducible and repeatable results.

- Know your product and the goals you hope to achieve
- Evaluate your testing equipment, current test methods and identify the global standards your product should meet
- Design a customized testing program

Material Screening

Check gross formulation errors with an artificially harsh exposure. These devices can also be used for relative rank comparisons between materials under specific conditions.

- The UVTest is the most affordable and easy-to-use fluorescent weathering device available. It's ideal for screening the effects of the sun's ultraviolet energy on your materials
- Our family of SUNTEST® flatbed xenon instruments is perfect for screening new materials for various end-use environments. It allows you to set the quality control on incoming materials and components, conduct routine testing during production and test 3-D samples

Accelerated Laboratory Testing

Reduce the time it takes to replicate similar exposures seen in "real time" outdoor weathering tests.

- Run tests uninterrupted at multiple irradiance levels and temperatures
- Reduce test times and improve control of the three main weathering parameters - light, temperature and moisture
- Atlas water-cooled Ci Series Weather-Ometers and air-cooled Xenotest® instruments provide the most accurate accelerated weathering testing. They deliver constant levels of irradiance and offer precise temperature and humidity control



A complete weathering testing program gives you the full picture.

Outdoor Weathering Testing

Natural weathering testing provides confirmation and correlation to accelerated weathering tests.

- Sample is subjected to the actual fluctuations it will see in its end-use environment
- Our state-of-the-art EMMAQUA® uses 10 flat mirrors to concentrate sunlight onto a target board of samples, providing an unparalleled level of outdoor weathering testing, including our patented temperature and advanced moisture control system

Independent Laboratory Validation

Testing with an independent 3rd party verifies that your results are repeatable and reproducible.

- Implemented in parallel with each type of weathering test to establish a benchmark for product performance and durability
- Atlas operates a number of international labs with teams of weathering experts proficient in outdoor and accelerated laboratory exposure testing to validate your results

What Light is Right?

Choosing the “right light” is one of the first steps in creating an accurate and reliable weathering test program. Atlas® accelerated weathering instruments offer a variety of light sources to simulate the effects of natural sunlight. We will work with you to select a light source with the spectral power distribution closest to your end-use environment, ensuring the most reliable and accurate results.

Sunlight vs. Artificial Light Sources

A Comparison of Relative Spectral Power Distribution

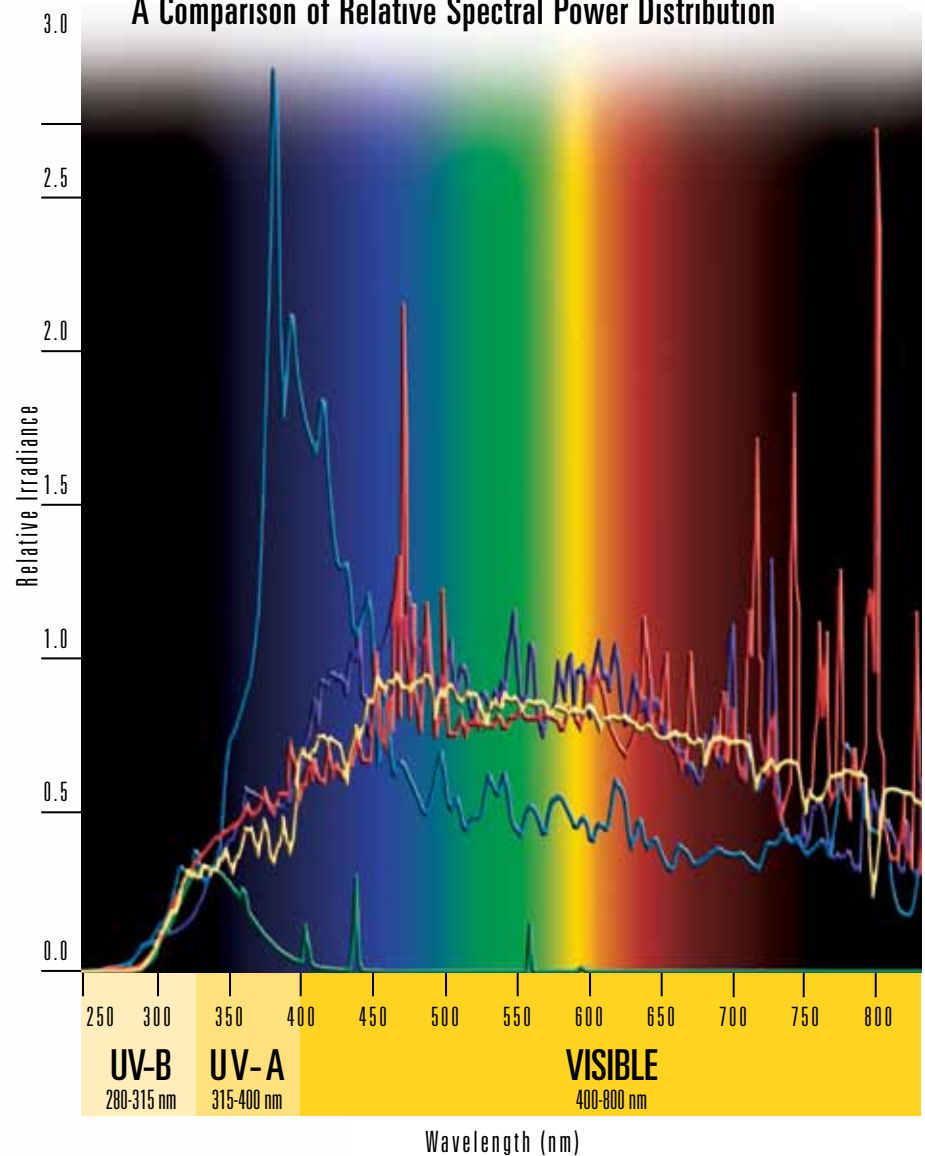

● **Global Solar Radiation**

Average Miami Sunlight
26° South Direct.

● **Xenon Arc Lamp**

As used in an Atlas
Weather-Ometer®
with Right Light™ filters.

● **UVA-340
Fluorescent Lamp**

Commonly used
in the Atlas UVTest.

● **Metal Halide**

As used in the SolarClimatic
340, 600, 1000 and 2000 systems
equipped with MHG
(Metal Halide Global) lamps.

● **Sunshine Carbon Arc**

As used in an
Atlas Weather-Ometer
with Corex D filters.

Sunlight Measurements		Irradiance Ranges W/m ²				
		300-400 nm	340 nm	420 nm	300-800 nm	300-2450 nm
Average Optimum Natural Daylight	Measured 45° South Cloudless Miami, FL	28	0.30	0.67	287	
Peak Natural Daylight	Measured solar noon on Vernal Equinox at normal incidence Miami, FL	66	0.70	1.53	617	
Peak Natural Daylight Standard	Defined for Horizontal Plane (0°) in CIE Publication No. 85 Table 4	69	0.68	1.50	669	1088

Filter Combination Charts

Filter Combinations		Test Conditions	Irradiance Ranges W/m ²			
Inner	Outer		Wattage	300-400 nm	340 nm	420 nm
Ci3000+			Min. Max.			
Right Light™	Quartz	Weathering tests requiring a precise match for solar cut-on, full spectrum match and/or cooler test temperatures	1800 W 4500 W	48 180	0.49 1.77	0.95 3.34
Type S Boro	Type S Boro	Most common combination for weathering tests (Daylight filter system)	1800 W 4500 W	40 151	0.35 1.33	0.85 3.08
Type S Boro	Soda Lime	Most common combination for lightfastness tests behind window glass	1800 W 4500 W	35 136	0.28 1.12	0.83 3.09
Type S Boro	Soda Lime + Float Glass in Auxiliary Lantern	Common combination for testing European automotive interior trim materials (Requires lantern assembly)	1800 W 4500 W	29 112	0.21 0.82	0.74 2.75
Quartz	Type S Boro	Weathering tests with somewhat more and shorter UV than sunlight	1800 W 4500 W	45 172	0.42 1.61	0.85 3.09
Quartz	Quartz	Testing with consistently more and shorter (unrealistic) UV than global solar radiation	1800 W 4500 W	52 205	0.48 1.92	0.87 3.21
Quartz	Cira on Type S Boro	Weathering tests requiring full spectrum match and/or cooler test temperatures	1800 W 4500 W	47 181	0.44 1.74	0.88 3.24
Ci4000			Min. Max.			
Right Light	Quartz	Weathering tests requiring the most precise match to sunlight available	2500 W 7500 W	35 168	0.35 1.68	0.66 2.99
Right Light	CIRA Coated Quartz	Weathering tests requiring the most precise match to sunlight available and lower test specimen temperatures	2500 W 7500 W	35 169	0.34 1.69	0.66 2.99
Type S Boro	Type S Boro	Most common combination for weathering tests (Daylight filter system)	2500 W 7500 W	29 141	0.25 1.26	0.59 2.76
Type S Boro	Soda Lime	Most common combination for lightfastness tests behind window glass	2500 W 7500 W	28 129	0.23 1.10	0.61 2.76
Quartz	Type S Boro	Weathering tests with somewhat more and shorter UV than sunlight	2500 W 7500 W	32 161	0.29 1.50	0.59 2.79
Quartz	Cira on Type S Boro	Weathering tests requiring full spectrum match and/or lower test temperatures	2500 W 7500 W	33 168	0.31 1.57	0.60 2.93
Type S Boro	Soda Lime + Float Glass in Auxiliary Lantern	Common combination for testing European automotive interior trim materials (Requires lantern assembly)	2500 W 7500 W	23 109	0.17 0.82	0.56 2.54
Quartz	Cira on Soda Lime + Float Glass in Auxiliary Lantern	Lightfastness test for automotive interior materials to meet GMW 3414TM		97	0.80	2.20
Quartz	Type S Boro + 335 nm long pass filter in Auxiliary Lantern	Lightfastness test for automotive interior materials to meet Ford FLTM B0 116-01		46	0.38	1.06
HL 35/65/4000	HL 3000/4000	Lightfastness test for automotive interior materials according to ISO 105-B06, VDA 75202 and European company specifications		60	0.55	1.40
Ci5000			Min. Max.			
Right Light	Quartz	Weathering tests requiring the most precise match to sunlight available	5000 W 14000 W	42 169	0.40 1.68	0.81 3.13
Right Light	CIRA Coated Quartz	Weathering tests requiring the most precise match to sunlight available and lower test specimen temperatures	5000 W 14000 W	42 170	0.40 1.66	0.81 3.20
Type S Boro	Type S Boro	Most common combination for weathering tests (Daylight filter system)	5000 W 14000 W	33 139	0.28 1.24	0.71 2.87
Type S Boro	Soda Lime	Most common combination for lightfastness tests behind window glass	5000 W 14000 W	31 128	0.26 1.09	0.73 2.87
Type S Boro	Soda Lime + Float Glass in Auxiliary Lantern	Common combination for testing European automotive interior trim materials (Requires lantern assembly)	5000 W 14000 W	26 108	0.20 0.81	0.67 2.63
Quartz	Type S Boro	Weathering tests with somewhat more and shorter UV than sunlight	5000 W 14000 W	39 158	0.35 1.48	0.74 2.90
Quartz	Cira on Type S Boro	Weathering tests requiring full spectrum match and/or lower test temperatures	5000 W 14000 W	40 166	0.37 1.55	0.78 3.04
Quartz	Cira on Soda Lime + Float Glass in Auxiliary Lantern	Lightfastness test for automotive interior materials to meet GMW 3414TM		91	0.75	2.20
Quartz	Type S Boro + 335 nm Long Pass Filter in Auxiliary Lantern	Lightfastness test for automotive interior materials to meet Ford FLTM B0 116-01		45	0.34	1.06

Filter Combination Charts

Filter Combinations		Test Conditions	Irradiance Ranges W/m ²	
Inner	Outer		Wattage	300-400 nm
Xenotest® Alpha+			Min. Max.	
4 Infrared + 3 Window Glass	UV Special Glass	Simulation of solar radiation behind window glass at higher temperatures	950 W 2750 W	40 140
2 Infrared + 5 Window Glass	UV Special Glass	Simulation of solar radiation behind window glass for AATCC TM 16H-1998	950 W 2750 W	40 140
7 Infrared	UV Special Glass	Simulation of solar radiation behind window glass (e.g. ISO 105 B02)	950 W 2750 W	40 140
6 Infrared + UV Window	UV Special Glass	Simulation of solar global radiation outdoors (daylight) – (e.g. Marks & Spencer, ISO 105 B04)	950 W 2750 W	40 140
10 Window Glass	UV Special Glass	Simulation of solar radiation behind window glass at higher temperatures, for testing of automotive interior materials (e.g. ISO 105 B06)	950 W 2750 W	40 110
10 XENOCHROME 320	UV Special Glass	Non-aging for simulation of solar radiation behind window glass (e.g. AATCC TM 16)	950 W 2750 W	40 180
10 XENOCHROME 300	UV Special Glass	Non-aging for simulation of solar global radiation outdoors (daylight) according to CIE publication No. 85 Table 4	950 W 2750 W	40 220
Daylight Extended IR	UV Special Glass	Simulation of outdoor solar radiation in accordance with CIE publication No. 85, Table 4, normal temperatures (e.g. ISO 4892-2 or ISO 11341)	950 W 2750 W	40 125
Xenotest Beta+ /Beta+ FD			Min. Max.	
11 XENOCHROME 320	UV Special Glass	Non-aging for simulation of solar radiation behind window glass (e.g. ISO 105 B02)	1200 W 2800 W	35 100
11 XENOCHROME 300	UV Special Glass	Non-aging for simulation of solar global radiation outdoors (daylight) according to CIE publication No. 85 Table 4 (e.g. ISO 4892-2, 11341)	1200 W 2800 W	45 120
Xenotest 150 S+			Min. Max.	
7 Infrared	UV Special Glass	Simulation of solar radiation behind window glass	950 W 2750 W	30 70
6 Infrared + UV Window	UV Special Glass	Simulation of solar global radiation outdoors (daylight) – needed for older standard requirements	950 W 2750 W	30 70
Xenotest 220/220+			Min. Max.	
11 XENOCHROME 320	UV Special Glass	Non-aging filters for simulation of solar radiation behind window glass compliant to ISO 105-B02	1200 W 2800 W	30 50
6 TM 16	UV Special Glass	Non-aging filters for simulation of solar global radiation behind window glass compliant to AATCC TM 16	1200 W 2800 W	30 50

Filter Combinations		Test Conditions	Irradiance Ranges W/m ²	
Inner	Outer		Wattage	300-3000 nm
SC340 MH/MHG			MH Max.	MHG Min./Max.
Indoor Flat		Simulation of solar radiation behind window glass	996	664/996
Outdoor Flat		Simulation of solar global radiation outdoors (daylight)	1200	800/1200
SC600 MH/MHG			MH Max.	MHG Min./Max.
Indoor Flat		Simulation of solar radiation behind window glass	830	664/996
Outdoor Flat		Simulation of solar global radiation outdoors (daylight)	1000	800/1200
SC1000 MH/MHG			MH Max.	MHG Min./Max.
Indoor Flat		Simulation of solar radiation behind window glass	830	664/996
Outdoor Flat		Simulation of solar global radiation outdoors (daylight)	1000	800/1200
SC2000 MH/MHG			MH Max.	MHG Min./Max.
Indoor Flat		Simulation of solar radiation behind window glass	830	664/996
Outdoor Flat		Simulation of solar global radiation outdoors (daylight)	1000	800/1200

*To match Atlas® filter combinations to performance-based standards requirements, contact your local Atlas representative.

Filter Combination Charts

Filter Combinations		Test Conditions	Irradiance Ranges W/m ²			
Base	Additional		Wattage	300-400 nm	340 nm	420 nm
SUNTEST® XXL/XXL+			Min. Max.			
Coated Quartz Glass ¹	None	Simulation of severe (unnatural) UV stress	900 W 1900 W	40 65	0.32 0.60	0.75 1.44
Coated Quartz Glass ¹	Daylight	Non-aging for simulation of solar global radiation outdoors (daylight)	900 W 1900 W	40 65	0.32 0.60	0.75 1.44
Coated Quartz Glass ¹	Window Glass	Non-aging for simulation of solar radiation behind 3 mm window glass	900 W 1900 W	30 65	0.26 0.56	0.65 1.28
Uncoated Quartz Glass ²	None	Simulation of severe (unnatural) UV stress at elevated temperature	900 W 1900 W	40 65	0.32 0.60	0.75 1.44
Uncoated Quartz Glass ²	Daylight	Non-aging for simulation of solar global radiation outdoors (daylight) at elevated temperature	900 W 1900 W	40 65	0.32 0.60	0.75 1.44
Uncoated Quartz Glass ²	Window Glass	Non-aging simulation of solar radiation behind 3 mm window glass at elevated temperature	900 W 1900 W	30 65	0.26 0.56	0.65 1.28
SUNTEST XLS+			Min. Max.	300-400 nm	300-800 nm	LUX (klx)
Uncoated Quartz Glass ³	None	Simulation of severe (unnatural) UV stress	900 W 1900 W	27 65	250 765	45 130
Uncoated Quartz Glass ³	Daylight	Non-aging for simulation of outdoor solar radiation (daylight)	900 W 1900 W	27 65	250 765	45 130
Uncoated Quartz Glass ³	Window Glass	Non-aging for simulation of daylight behind window glass (solar radiation behind 3mm window glass)	900 W 1900 W	27 60	250 765	45 130
Uncoated Quartz Glass ³	Solar ID65	Simulation of solar radiation behind 6 mm window glass, e.g. for photostability testing of pharmaceuticals; meets CIE ID65 according to ICH Guideline	900 W 1900 W	27 60	250 765	45 130
Uncoated Quartz Glass ³	StoreLight™	Simulation of exposure inside stores or supermarkets, e.g. for testing of food, beverages and packaging	900 W 1900 W		250 765	45 130
SUNTEST CPS/CPS+			Min. Max.	300-800 nm		
Coated Quartz Glass	None	Filter system A (max. UV): Simulation of severe (unnatural) UV stress	800 W 1700 W	250 765		
Coated Quartz Glass	UV Special Glass	Filter system B: Simulation of solar global radiation outdoors (daylight)	800 W 1700 W	250 765		
Coated Quartz Glass	Special Window Glass	Filter system C: Simulation of exposure behind 3 mm window glass	800 W 1700 W	250 765		
Uncoated Quartz Glass	None	Filter system D: Simulation of severe (unnatural) UV stress at elevated temperature	800 W 1700 W	250 765		
Uncoated Quartz Glass	UV Special Glass	Filter system E: Simulation of solar global radiation outdoors (daylight) at elevated temperature	800 W 1700 W	250 765		
Uncoated Quartz Glass	Special Window Glass	Filter system F: Simulation of solar radiation behind 3 mm window glass at elevated temperature	800 W 1700 W	250 765		
Coated Quartz Glass	Special Window Glass Plus Solar ID65	Filter system G (Solar ID65): Simulation of solar radiation behind 6 mm window glass, e.g. for photostability testing of pharmaceuticals; meets CIE ID65 according to ICH Guideline	800 W 1700 W	250 765		
Coated Quartz Glass	Solar Standard	Filter system H (Solar Standard): Simulation of solar radiation outdoors according to DIN 67501:1999	800 W 1700 W	250 765		
Coated Quartz Glass	StoreLight	Filter system I (StoreLight): Simulation of exposure inside stores or supermarkets, e.g. for testing of food, beverages and packaging	800 W 1700 W	250 765		

1 Coated quartz glass for use in a SUNTEST XXL/XXL+ with Alu-reflector standard lamp cassette.

2 Uncoated quartz glass for use in a SUNTEST XXL/XXL+ with selectively reflecting mirrored lamp cassette.

3 Production standard. Coated Quartz available, allowing lower test temperatures via selective reflection of IR-radiation.



Spectral Power Distribution Charts

The charts below are representative Spectral Power Distribution (SPD) graphs of our accelerated weathering light sources as compared to sunlight. A variety of filter combinations are available for our Xenon and Metal Halide light sources (see pages 6-8), which can help alter the SPD to provide the closest match to your end-use environments.

(Note- scales vary to highlight specific SPDs)

Right Light™ vs. Daylight

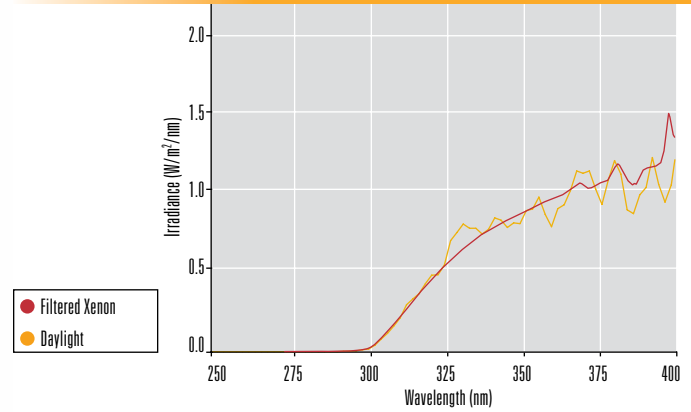

Right Light Filter System vs. Sunlight vs. Type S/Type S

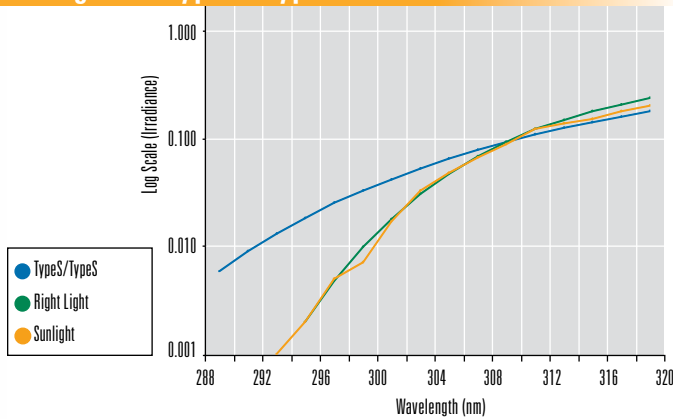

Type S Boro/Soda Lime vs. Daylight Behind Window Glass

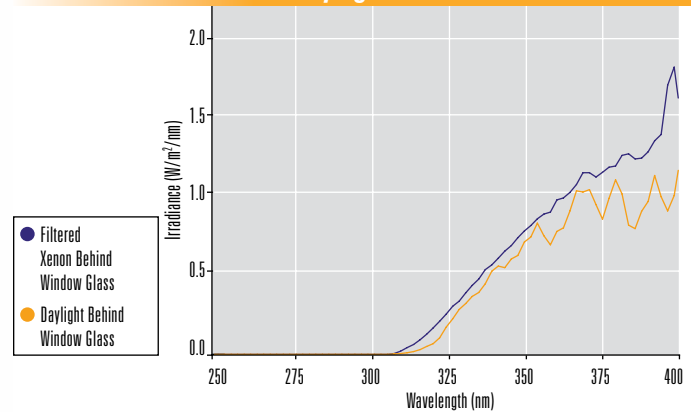

Type S Boro/Soda Lime vs. Daylight Behind Window Glass

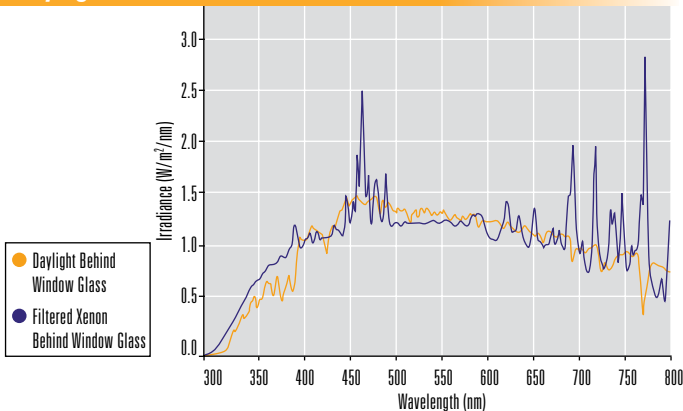

XENOCHROME 320 vs. Daylight Behind Window Glass

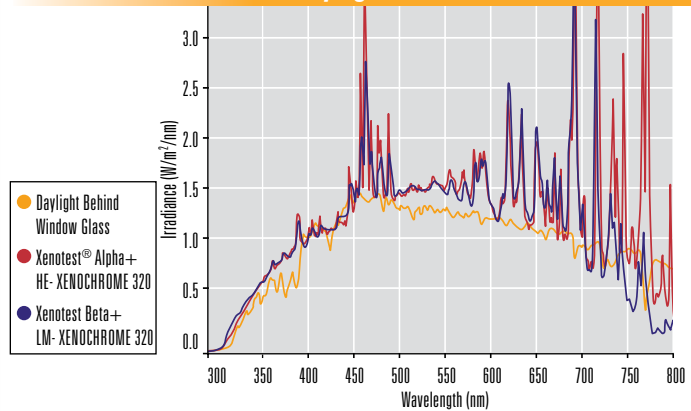

Ford FLTM BO 116-01 and GMW 3414 TM vs. Daylight Behind Window Glass

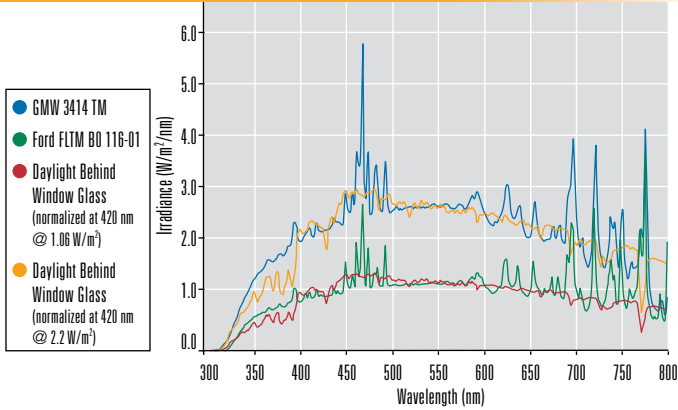

SAE J2412/J2527 vs. Daylight

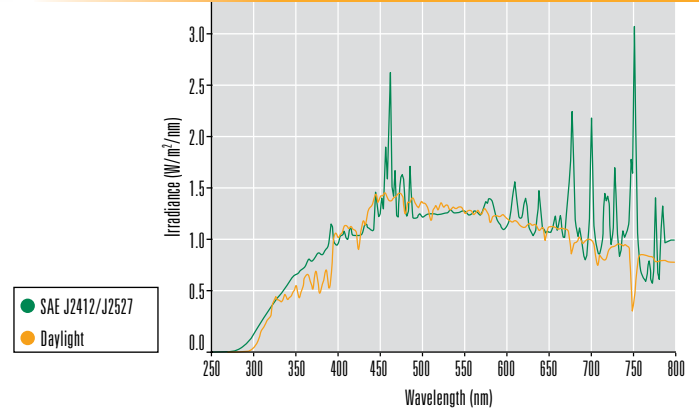

Filtered Metal Halide vs. Daylight

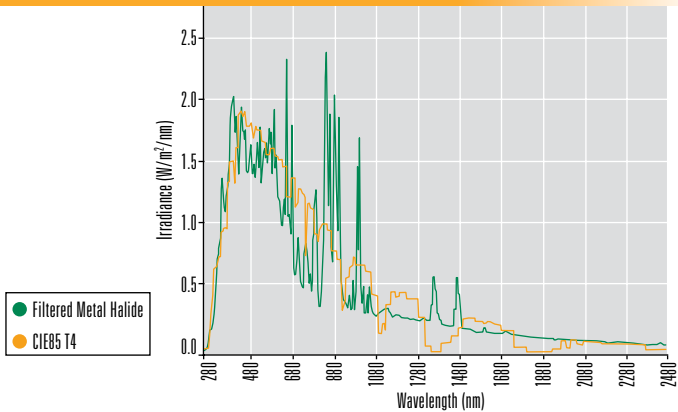

Filtered Metal Halide Behind Window Glass vs. Daylight Behind Window Glass

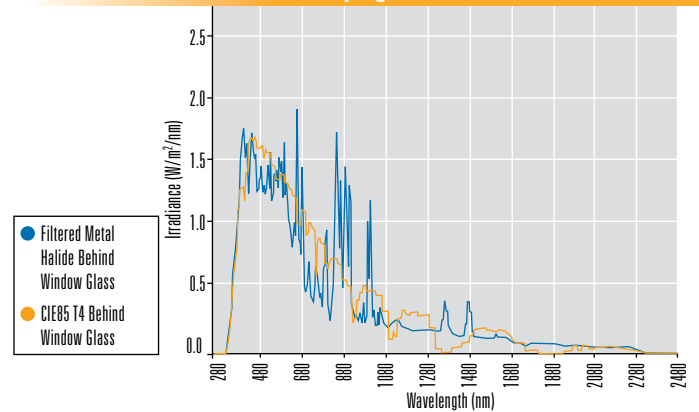

Fluorescent UV Lamps vs. Daylight

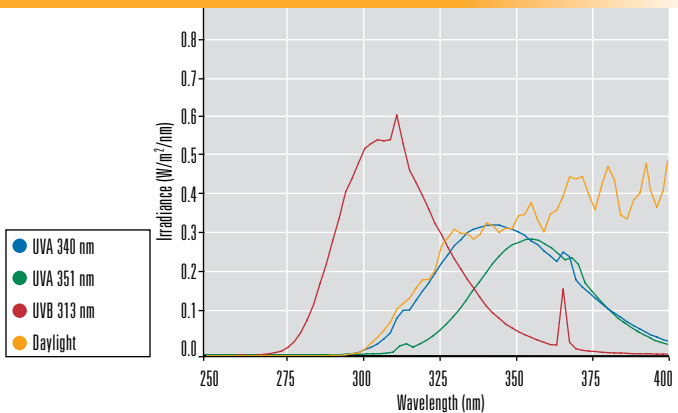

EMMAQUA® vs. Daylight

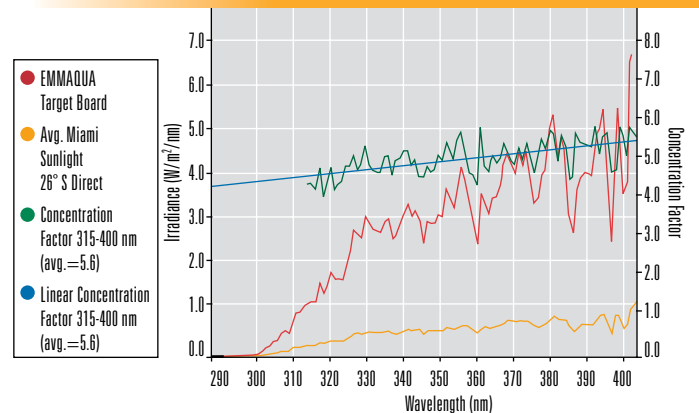



Control Panel

Touch screen interface allows operator to select from preset test program or enter custom test programs.

Irradiance Uniformity

Light at various points from lamp at equal intensity. Notice how the lobe lines up with all three specimen tiers for an even light distribution.

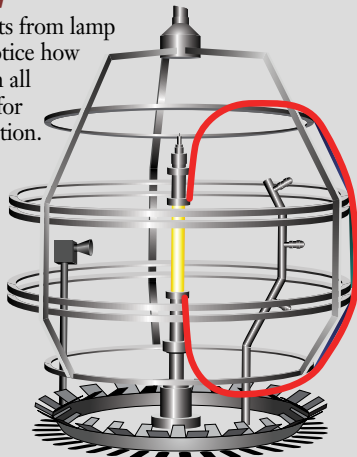

The Ci Series Weather-Ometers

Digital Control for Reliable Accelerated Weathering Testing

The Ci Series represents a significant advancement in applying digital and optical technologies in a laboratory weathering instrument. Controlled Irradiance (Ci) Xenon Arc Systems deliver constant levels of irradiance and the most precise temperature and humidity control in the industry, helping to establish new standards of performance for correlation, accuracy, reproducibility and repeatability.

Unmatched Repeatability and Reproducibility

Innovations in airflow, irradiance control and control systems dramatically reduce variability in test parameters, providing new levels of uniformity for temperature, humidity and light exposure.

Reliable Replication of Full Spectrum Sunlight

The Ci Series uses the most advanced water-cooled xenon arc lamps to deliver constant amounts of radiant exposure test after test. Easily interchangeable glass filters tailor the xenon light spectrum to match sunlight conditions in a sample's end use environment.

User-Friendly Operating Convenience

Intuitive TFT LCD touch screen increases functionality that makes the Ci Series easy to program, monitor and calibrate. Irradiance, temperature, humidity and sprays can be set to any level and duration for user defined custom test cycles.

Faster, Easier Servicing Reduces Downtime

Full front access to controls and test chamber, user-serviceable components, diagnostic screens, automatic lamp calibration and improved component life significantly reduce maintenance time and cost, improving long-term reliability.

Meets Global Weathering and Lightfastness Test Requirements

The Ci Series meets a wide variety of international standards, as well as numerous manufacturer-specific test methods for the determination of material durability.



Ci Series Features and Benefits

- Rotating rack maximizes exposure uniformity over all specimens
- Narrow band (340 nm or 420 nm), broad band (300–400 nm) irradiance control with optional monitoring or illuminance control (LUX) at 400–750 nm at a second wavelength to meet global test requirements
- Controlled irradiance up to 2-sun levels for higher acceleration based on your test requirements
- ASTM Black Panel Thermometer or ISO/DIN Black Standard Thermometer controls and monitors temperature at specimen level to ensure test repeatability from one test to the next
- Simultaneous, automatic control of both chamber temperature and Black Panel Temperature closely simulates your material's end-use temperature conditions test after test
- Optional S³T feature provides real-time measurement of sample temperatures while on exposure
- VibraSonic™ humidity control accurately replicates user selectable humidity levels to meet stringent global test requirements
- Smart Damper™ tightly controls test chamber temperature, BPT and humidity levels and compensates for changes in ambient laboratory conditions for more accurate and repeatable tests
- Smart Light Monitor™ verifies that the correct light capsule is installed
- Xenon lamp cooling system dramatically reduces amount of cooling water used

The Power and Capacity to Meet Your Needs

Ci5000 Weather-Ometer®

Our largest capacity, most powerful accelerated weathering instrument. Features a 12000 W water-cooled xenon arc lamp and a total exposure area of 11000 cm². The best exposure area per cost ratio in the industry.

Ci4000 Weather-Ometer

Capable of meeting global test specifications in a mid-size, accelerated weathering instrument. Features a 6500 W water-cooled xenon arc lamp and a total exposure area of 6500 cm².

Ci3000+ Weather-Ometer and Fade-Ometer®

Affordable xenon arc weathering testing with all the benefits of the Ci Series in an economical, compact instrument. The Weather-Ometer tests for material weatherability, while the Fade-Ometer accurately tests textiles for lightfastness. Both feature a 4500 W water-cooled xenon arc lamp and a total exposure area of 2188 cm². Available 2-tier rack option nearly doubles sample capacity.

Common Applications

Automotive Coatings,
Fabrics and Plastics



Packaging

Paints, Coatings
and Pigments



Photovoltaics

Plastics



Textiles,
including Industrial
and Geotextiles



Window Profiles





Ci5000 Interior Chamber

RD-3T Holder

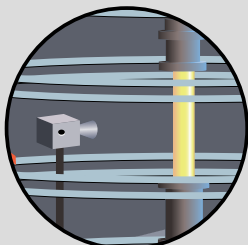

Light Monitor

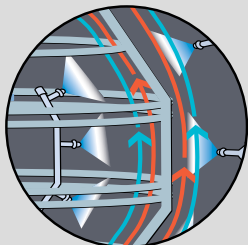

Specimen and Rack Spray

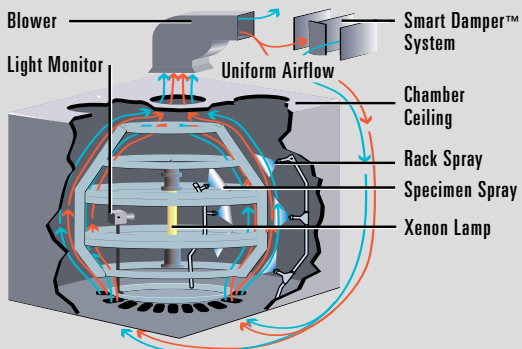

Standards

The Ci Series meets or exceeds the following industry standards:

AATCC	TM 16*	TM 16E-1998*	TM 169●▲■
ASTM	D2565* D6695* E1596* G151* G155*	The Ci Series meets all material standards that reference ASTM G151 and G155	
Ford	FLTM B0 116-01●▲		
GME	60292*		
GB/T	1865●▲■ 8427* 13492●▲■ 16422.2●▲■		
GMW	3414 TM* 14162*		
ISO	105-B02* 105-B04●▲■ 105-B06* 3917●▲■		
	4892-1●▲■ 4892-2●▲■ 11341●▲■ 12040*		
JASO	M 346*		
Marks & Spencer	C9■▼ C9A■▼		
MIL STD	810 G (Method 505.5)●▲■		
Peugeot/Citroen	D27 1389*		
Renault	D47 1431▼		
SAE	J1885●▲ J1960●▲ J2412●▲■ J2527●▲■		
VDA	621-429●▲ 621-430●▲ 75202*		
VW	PV 1303* PV 1306▲ PV 3929* PV 3930●▲■		

- Ci5000
- ▲ Ci4000
- Ci3000+
- ▼ Ci3000+ Fade-Ometer
- * All Ci Equipment

This is a sample of global standards that can be met by the Ci Series. For more information on additional or specific standards, contact your local Atlas® representative. Standards are subject to change without notice. This might lead to the inclusion or exclusion of certain instruments.

Temperature Control Performance

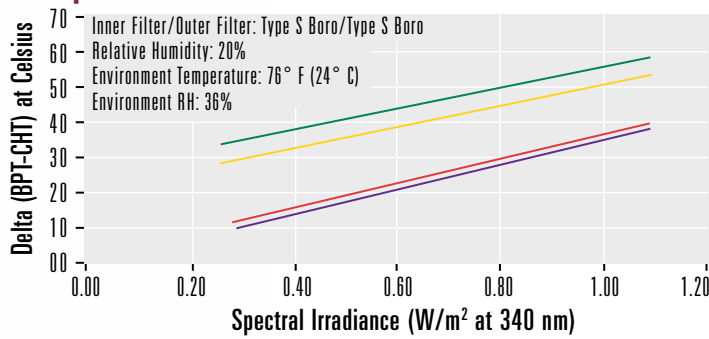

- Min. Delta BPT/CHT @ 60° C
- ▲ Min. Delta BPT/CHT @ 45° C
- Max. Delta BPT/CHT @ 45° C
- ▼ Max. Delta BPT/CHT @ 60° C

Operable ranges of humidity control at various Black Panel Temperatures (under normal laboratory conditions) at normal irradiance levels. Data representative of a Ci4000. Other performance envelope data may vary. Contact your local sales representative for data on other instruments.

Atlas Xenon vs. Fluorescent vs. Outdoor Exposure

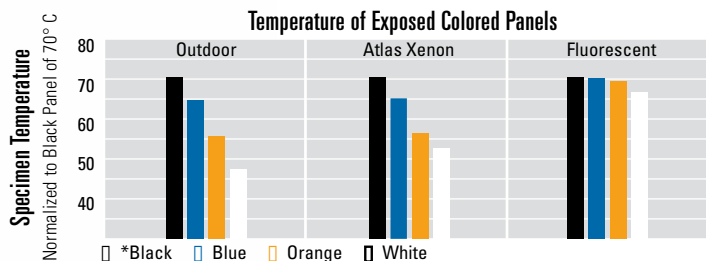

Note: Black Panel Temperature in the fluorescent device is achieved only by heating the chamber air (no IR). Thus, all specimens are heated equally without regard to color.



Ci Series Weather-Ometer® Features

	5000	4000	3000+	3000+ Fade-Ometer®
Positive alignment, quick disconnect xenon lamp system	12000 W	6500 W	4500 W	4500 W
Specimen rack capacity	11000 cm ²	6500 cm ²	2188 cm ²	2188 cm ²
2-tier rack capacity			3422 cm ²	3422 cm ²
Automatic irradiance control at narrow band (340 nm or 420 nm), broad band (300-400 nm) or illuminance control/LUX (400-750 nm)	●	●	●	●
TFT full color 12" touch screen control panel display of all test parameters	●	●	●	●
Automatic, on rack Black Panel Temperature control	●	●	●	●
Automatic chamber temperature control	●	●	●	●
Automatic blower speed control	●	●	●	●
Automatic test time countdown in kJ/m ²	●	●	●	●
Xenon lamp cooling system	●	●	●	●
Water purity meter	●	●	●	●
Smart Damper™	●	●	●	●
Calibration xenon reference lamp	●	●	●	●
VibraSonic™ humidification system	●	●	●	●
Automatic humidity control	●	●	●	●
Direct readout of relative humidity (%RH)	●	●	●	●
Touch screen diagnostic message display	●	●	●	●
Main power disconnect switch	●	●	●	●
Meets CE, UL, CSA, ISO and EN compliance	●	●	●	●
S ³ T - Specific Specimen Surface Temperature System	■	■	N/A	N/A
Instrument footprint (including access area) in centimeters	212 x 293	180 x 272	146 x 256	146 x 256
Chamber air refrigeration	■	■	N/A	N/A
Lamp cooling refrigeration	■	■	■	■
LiquiAir™ xenon lamp cooling system	■	■	■	■
2-tier rack	▲	▲	■	■
Data acquisition software package with serial/USB interface	■	■	■	■
Dual Black Panel/Black Standard Temperature measurement	■	■	■	■
Multiple rack mounted temperature sensors	■	■	■	■
Monitoring of second wavelength	■	■	■	■
XenoCal irradiance calibration device	■	■	■	■

● Standard ■ Optional ▲ Custom Design

Specific Utility Requirements and Specifications for each instrument can be found on page 27, SPD graphs on pages 9-10, Filter Combinations on page 6 and Specimen Holders on pages 31.



Xenotest® Instruments

Xenotest Beta+

Versatile, Compact Design Without Compromising Sample Capacity

The Xenotest Beta+ sets the standard in air-cooled xenon technology, offering fast and reliable answers to product weatherability questions. By incorporating a variety of optional features, the Beta+ can meet virtually all global weathering and lightfastness test requirements.

Xenotest Beta+ FD

Realistic Food & Drink Testing

The Xenotest Beta+ FD is the ideal full-spectrum solution for realistic photostability testing of packaged consumer goods. Specially designed specimen racks support common bottle shapes and sizes or flexible packaging. A chiller system guarantees realistic temperature conditions.

Xenotest Alpha+

Advanced Light Exposure and Weathering Instrument

The Xenotest Alpha+ provides reproducible and repeatable test results of lightfastness and weatherability using an air-cooled xenon arc light source and the ability to perform high irradiance tests up to 3-sun.

Xenotest 150 S+

Compact, Easy-To-Use Xenon Arc Testing – a Standard of the Textile Industry

The Xenotest 150 S+ combines the latest in weathering testing technology, economical testing, optimum reproducibility and good correlation to natural weathering, to deliver an instrument that has helped set the standard in textiles material durability testing.

Xenotest 220/220+

The Economical Solution for Textile Lightfastness Testing

The Xenotest 220 is a large capacity lightfastness tester dedicated to textile testing. With the ability to test 38 samples, the 220 provides nearly twice as much capacity in the same footprint compared to 150S+. Its large test chamber, non-aging filters and efficient use of power and water make it today's most economical air-cooled instrument available.



Xenotest® Features and Benefits

- Rotating rack maximizes exposure uniformity over all specimens
- Sophisticated touch screen with color display to indicate the current test status and the graphic progression of the test parameters
- Online features via Ethernet for easy programming and monitoring from remote access
- Non-aging XENOCHROME® filter systems decrease cost of operation
- Simultaneous, automatic control of both chamber temperature and Black Standard Temperature closely simulates your material's end-use temperature conditions test after test
- On-rack XENOSENSIV® sensor for precise control of both irradiance and temperature on sample level
- Omega-shaped xenon lamp guarantees constant irradiance of up to 3-sun levels while eliminating an undesired increase in infrared radiation
- Generous power reserve of the xenon lamp ensures longer lamp life even when switching from non-turning to turning mode
- Basic, functional design keeps the instrument affordable and economical

Advanced Sensor Technology

Xenotest instruments use the most reliable sensor technology to measure UV irradiance between 300 and 400 nm and Black Standard Temperature at the sample level. Stationary temperature and humidity sensors measure and control the ambient temperature and humidity in the test chamber.

Meets International Weathering and Lightfastness Test Standards

The Xenotest instruments meet a variety of international standards, as well as numerous industrial and manufacturer specific test methods.

User Friendly Operating Convenience

- Multiple European and Asian languages for easy operation
- Pre-programmed with the most common standard test methods
- Add-ons for easy online programming and monitoring

Common Applications

Automotive Coatings,
Fabrics and Plastics



Packaging

Paints, Coatings
and Pigments



Plastics

Textiles



Window Profiles

Other Applications:

Pharmaceuticals
Printing Inks
Industrial Geotextiles

Accelerated Weathering Products



Standard Xenotest Chamber

Stainless steel rotating rack with XENOSENSIV on-rack sensor for controlling irradiance and temperature on sample level. Premium air-cooled xenon arc lamps and rack capacities of 1320 cm², 2310 cm² and 4000 cm².

Optical Filters

Provide spectra according to standards.



Chamber Humidity and Temperature

Ultrasonic humidifiers generate precise steam-like dispersion. Airflow optimized for efficiency and high uniformity of humidity and temperature on the rack.



Standards

Xenotest[®] instruments meet or exceed the following industry standards:

AATCC	TM 16 ●▼			TM 16H-1998 ●▲
	TM 169*			
ASTM	D2565 ●▲	D6695 ●▲	E1596 ●▲	
	G151 ●▲	G155 ●▲		
DIN	EN513 ■			
GB/T	8427*	1865 ●■	13492 ●■	16422.2 ●■
GME	60292 ●■			
GMW	3414 TM ●■	14162 ●■		
ISO	105-B02*	105-B04 ●▲	105-B06 ●■	3917 ●■
	4892-1 ●■	4892-2 ●■	11341 ●■	12040 ●▲
JASO	M 346 ●▲			
Marks & Spencer	C9 ●▲▼		C9A ●▲▼	
RAL-GZ	716/1 ■			
VDA	621-429 ●	621-430 ●	75202 ●■	
VW	PV 1303 ●■	PV1306 ■	PV 3929 ■	PV 3930 ■

- Alpha+
- Beta+
- ▲ 150 S+
- ▼ 220/220+

* All Xenotest Equipment

This is a sample of global standards that can be met by this instrument. For more information on additional or specific standards, contact your local Atlas[®] representative.

Standards are subject to change without notice. This might lead to the inclusion or exclusion of certain instruments.

Temperature Control Performance for Outdoor Solar Radiation (XENOCROME 300)

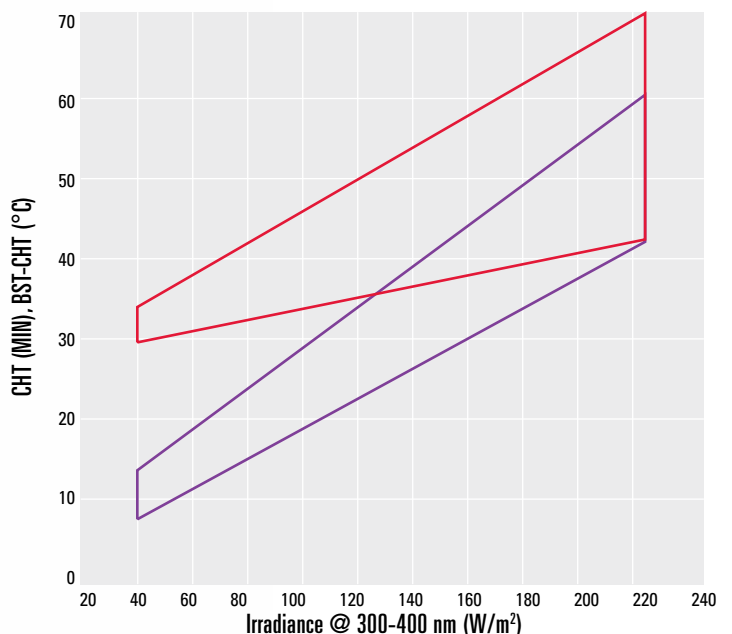

- BST-CHT
- CHT (MIN)

Operable ranges of Black Standard Temperature and Chamber Temperature at various irradiance levels (under normal laboratory conditions).



Xenotest® Features

	Beta+	Beta+ FD	Alpha+	150S+	220	220+
Air-cooled xenon lamps	2200 W (3)	2200 W (3)	2200 W (1)	2200 W (1)	2200 W (1)	2200 W (1)
Specimen rack capacity	4000 cm ²	4000 cm ²	1320 cm ²	1320 cm ²	2310 cm ²	2310 cm ²
On-rack XENOSENSIV sensor for controlling irradiance at 300-400nm and Black Standard Temperature (BST) on sample level	●	●	●	N/A	●	●
Automatic simultaneous BST and CHT control	●	●	●	N/A	●	●
Test chamber heating device	●	●	●	●	●	●
Automatic blower speed control	●	●	●	●	●	●
Ultrasonic humidification system	●	N/A	●	●	●	●
Automatic humidity control	●	N/A	●	●	●	●
Specimen spray system	●	N/A	●	●	N/A	N/A
Back spray system	●	N/A	N/A	N/A	N/A	N/A
Integrated water reservoir (60 l)	●	N/A	●	●	●	●
Turning or Non-Turning mode	N/A	N/A	●	●	N/A	N/A
Microprocessor control	●	●	●	●	●	●
TFT full color 5.7" touch screen control panel display of all test parameters	●	●	●	●	N/A	●
Multiple languages available (Asian and European)	●	●	●	●	●	●
Graphic display of the progression of your test parameters	●	●	●	●	N/A	●
Parameter check	●	●	●	●	●	●
Automatic test time countdown in kJ/m ²	●	●	●	●	●	●
Data acquisition via interfaces RS232, USB, or memory card	●	●	●	●	RS232	●
Software updates via memory card	●	●	●	●	●	●
Internal memory chip for storing instrument data	●	●	●	●	●	●
Main power disconnect switch	●	●	●	●	●	●
CE compliant	●	●	●	●	●	●
Instrument dimension (WxDxH) in cm	90x120x180	90x120x181	90x78x180	90x78x180	90x78x180	90x78x180
XenoTouch Add-ons for online programming and monitoring	■	■	■	■	N/A	■
Thermoprinter	■	N/A	■	■	N/A	N/A
Chamber air refrigeration	N/A	■	N/A	N/A	N/A	N/A
XenoCal® BST Black Standard Thermometer	■	■	■	■	■	■
XenoCal WST White Standard Thermometer	■	■	■	■	■	■
XenoCal BB 300-400 Irradiance Sensor	■	■	■	■	■	■
XenoCal WB 300-800 Irradiance Sensor	■	■	■	■	N/A	N/A
XenoCal NB 340 Irradiance Sensor	■	■	■	■	N/A	N/A
BPT Sensor	■	N/A	■	■	■	■

● Standard ■ Optional

Specific Utility Requirements and Specifications for these instruments can be found on page 28, SPD graphs on pages 9-10. Filter Combinations on page 7 and Specimen Holders on page 32.



SUNTEST® Flatbed Xenon Instruments

Reliable Accelerated Xenon Exposure Systems

The SUNTEST family offers state-of-the-art, flatbed xenon exposure systems to test the long-term effects that light, heat and moisture will have on your products in their end-use environment. Since 1976 SUNTEST is the world's most widely used brand of flatbed xenon exposure systems.

Easy-to-Use System

These easy-to-use xenon instruments are perfect for screening new materials for various end-use environments, for quality control on incoming materials and components, to conduct routine testing during production and to test 3-D samples.

Reliable Replication of Full Spectrum Sunlight

The SUNTEST Series uses the most advanced air-cooled xenon arc lamps to deliver constant amounts of radiant exposure test after test. Easily interchangeable optical filters tailor the xenon light spectrum to match sunlight conditions in a sample's end-use environment.

SUNTEST Benefits

- Space-saving benchtop models
- Easy-to-use & program
- Proven quality since 1976
- Highly flexible - optional accessories expand testing capabilities
- Exposure area perfect for large, flat or 3-D specimens

SUNTEST
XXL+

SUNTEST XLS+

SUNTEST CPS+



XenoCal® Series

Calibrated sensors for measurement and/or instrument calibration of irradiance (BST and WST).



The Right Instrument for Your Testing Needs

The SUNTEST® family consists of three sizes to meet your capacity needs. Our smaller models offer a choice of manual control or microprocessor control. Our largest models, the XXL and XXL+, come with our easy-to-use color touch screen, and the ability to control all relevant weathering settings.

XXL/XXL+

The 3000 cm² specimen tray is perfect for high volume testing and testing of large components and three dimensional parts. Standard sample holders for flat samples guarantee maximum throughput. The exposure area has a slope of 5° to most accurately simulate outdoor testing and water run off from sample surfaces.

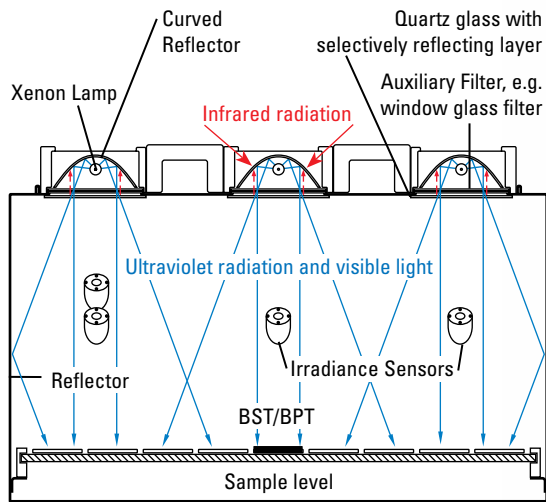

XLS+

With 1100 cm² of exposure area, the XLS+ is a perfect size for labs that don't have the need for the capacity of the XXL. This benchtop instrument has state-of-the-art controls, an easy-to-use color touch screen and various accessories setting the standard in benchtop weathering.

CPS/CPS+

This economical xenon test instrument is the smallest of the SUNTEST family with 560 cm² of exposure area. It is equipped with a flat specimen tray and is perfect for companies on a limited budget or for companies that occasionally have the need to test.

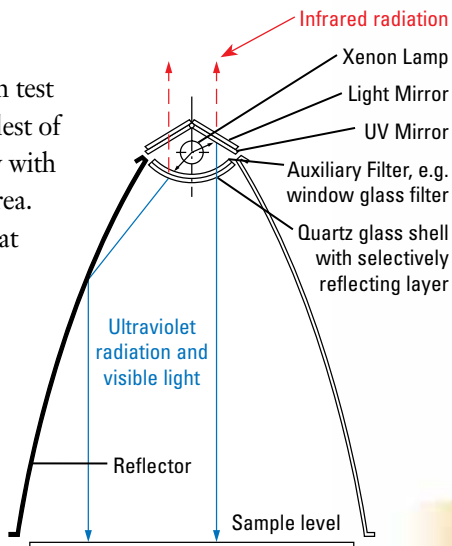

Common Applications

CDs and DVDs



Cosmetics

Packaging



Pharmaceuticals and Bio-Pharmaceuticals

Printing Inks



Textiles and Geotextiles

Other Applications:

- Agrochemicals
- Building Sealants
- Dental Materials
- Powder Coatings



Immersion Unit for Simulated Weathering Tests (CPS+ and XLS+)

- Allows for immersion of samples, such as paints or plastics to simulate exposure to moisture
- Immersion intervals selectable between 1 and 999 minutes
- Continuous flooding
- Water temperature control from 30° C to 45° C
- Flat, sub-frame design

SUNTEST® Options

Water-cooled Sample Table for Contact Cooling (CPS/CPS+ and XLS+)

- Allows for uniform cooling of samples through direct contact with the cooling surface
- Recommended for exposure of thermosensitive substances, such as agrochemicals or plastic foils
- Frequently used for testing cosmetics and pharmaceutical samples
- Easily interchangeable special sample table with tap water cooling

Chiller for Exposing Thermosensitive Materials (CPS/CPS+ and XLS+)

- Recommended when testing the photostability of pharmaceutical and cosmetic products
- Fresh air temperature cooling
- Reduction of the BST by up to 13° C (depending on unit and laboratory conditions)
- CFC-free refrigerants

Specimen spray for weathering testing (XLS+)

- Flat, sub frame design
- Automatic refill function
- Digitally controlled

Standards

The SUNTEST family meets or exceeds the following industry standards:

AATCC	TM16●	TM169●		
ASTM	C1442*	C1501*	D3424■▼	D5071■▼
	D6695*	G151*	G155*	
	The XXL/XXL+ meets all material standards that reference ASTM G151 and G155			
COLIPA	In vitro determination of UVA protection			
EPA/ASTM	E896*			
GB/T	1865●	8427*	13492●	16422.2*
ICH Guideline	Q1B■▼	Q5C■▼		
ISO	4049*	4665●	4892-1*	4892-2*
	7491*	10977■▼	11341●	11431*
	11979-5*	18909●		
VW	PV 1306●	PV 1323▼	PV 3929●	PV 3930●

- XXL/XXL+ ■ XLS+ ▼ CPS/CPS+ only with immersion unit
- * All SUNTEST Equipment

This is a sample of global standards that can be met by this instrument. For more information on additional or specific standards, contact your local Atlas representative.

Standards are subject to change without notice. This might lead to the inclusion or exclusion of certain instruments.



SUNTEST® Features

			XXL	XXL+	XLS+	CPS	CPS+
Air-cooled xenon lamps			1700 W (3)	1700 W (3)	1700 W (1)	1500 W (1)	1500 W (1)
Specimen rack capacity			3000 cm ²	3000 cm ²	1100 cm ²	560 cm ²	560 cm ²
Specimen tray size in cm x cm			79x39	79x39	39x30	28x20	28x20
SUNSENSIV sensor for controlling irradiance at 300-400nm / 340nm			●	●	●	N/A	N/A
SUNSENSIV sensor for controlling irradiance at 300-800nm / Lux			N/A	N/A	●	●	●
SUNSENSIV sensor for controlling irradiance at 420nm			●	●	N/A	N/A	N/A
Irradiance ranges							
	Daylight Filter	Window Glass Filter					
300-400 nm	40-65 W/m ²	30-65 W/m ²	●	●	●	N/A	N/A
340 nm	0.34-0.62 W/(m ² nm)	0.26-0.56 W/(m ² nm)	●	●	●	N/A	N/A
420 nm	0.75-1.45 W/(m ² nm)	0.65-1.30 W/(m ² nm)	●	●	N/A	N/A	N/A
300-800 nm	250-600 W/m ²	250-600 W/m ²	N/A	N/A	●	N/A	N/A
300-800 nm	250-765 W/m ²	250-765 W/m ²	N/A	N/A	N/A	●	●
LUX			N/A	N/A	●	N/A	N/A
Automatic CHT control			up to 70° C	up to 70° C	N/A	N/A	N/A
Automatic simultaneous BST and CHT control			●	●	N/A	N/A	N/A
BST range			45-100° C	45-100° C	45-100° C	N/A	45-100° C
BPT range			45-95° C	45-95° C	45-95° C	N/A	N/A
Automatic blower speed control			●	●	●	●	●
Ultrasonic humidification system			N/A	●	N/A	N/A	N/A
Automatic humidity control			N/A	●	N/A	N/A	N/A
Specimen spray system			●	●	N/A	N/A	N/A
Integrated water reservoir (60 l)			●	●	N/A	N/A	N/A
Microprocessor control			●	●	●	N/A	●
TFT full color 5.7" touch screen control panel display of all test parameters			●	●	●	N/A	●
Multiple languages available (Asian and European)			●	●	●	N/A	N/A
Graphic display of the progression of your test parameters			●	●	●	N/A	N/A
Parameter check			●	●	●	N/A	●
Automatic test time countdown in kJ/m ²			●	●	●	N/A	●
Data acquisition via interfaces RS232, USB, or memory card			●	●	●	RS232	RS232
Software updates via memory card			●	●	●	N/A	N/A
Internal memory chip for storing instrument data			●	●	●	N/A	N/A
Main power disconnect switch			●	●	●	●	●
CE compliant			●	●	●	●	●
Instrument dimension (WxDxH) in cm			90x91x172	90x91x172	90x54x62	78x35x35	78x35x35
XenoTouch add-ons for online programming and monitoring			■	■	■	N/A	N/A
SunCool chamber air refrigeration			■	■	■	■	■
SunSpray specimen spray system			■	■	■	N/A	N/A
SunFlood test chamber immersion system			N/A	N/A	■	N/A	■
SunTray sample exchanger			N/A	N/A	N/A	N/A	■
Water-cooled sample table for contact cooling			N/A	N/A	■	■	■
XenoCal® BB 300-400 BST Irradiance+Temperature Sensor			■	■	■	N/A	N/A
XenoCal WB 300-800 BST Irradiance+Temperature Sensor			■	■	■	■	■
XenoCal LUX BST Irradiance+Temperature Sensor			■	■	■	N/A	■

● Standard ■ Optional

Specific Utility Requirements and Specifications for this instrument can be found on page 29, and Filter Combinations on page 8.



Stacking

UVTest can be stacked in any configuration.

Specimen Mounting

UVTest specimen retaining rings have been ergonomically designed for faster and easier repeated loading and unloading of specimens.

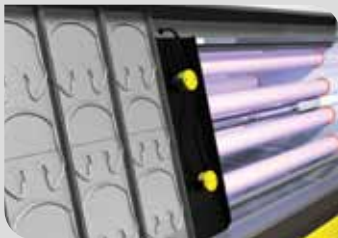

Irradiance Calibration

The state-of-the-art UVTest irradiance calibrator has near-cosine-response-optics and four separate irradiance channels.

Safer Calibration

The UVTest has irradiance calibration access ports allowing irradiance calibration without bypassing the door safety interlock switch when the lights are on, reducing the user's risk of exposure to harmful UV radiation.



UVTest

The Most Affordable, Easy-To-Use Fluorescent Weathering Device with Controlled Irradiance Available

The Atlas® UVTest is designed for economical weathering testing with the sophistication of Atlas' 90 years of weathering expertise. Innovative design features improve test reproducibility and lower operating costs while testing a variety of materials for their reaction to UV, temperature and moisture.

User Interface

The UVTest user interface is a simple-to-use touch screen controller, pre-programmed with most common industry tests. It has a main screen where all critical test parameters are displayed in one convenient location, and easily provides trend plots, alarm messages and maintenance schedules. It is available in several languages, including English, Chinese, Japanese, Korean, French, German, Spanish and Portuguese.

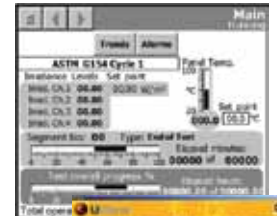

Remote Data Acquisition

The UView data acquisition PC application allows remote monitoring and storing of critical UVTest data from multiple units over the customer's LAN Ethernet connection.



Chamber Diagram

A heated reservoir below the test chamber produces water vapor that rises to the upper chamber where specimens will be exposed to UV radiation and uniform wetting at 100% relative humidity.

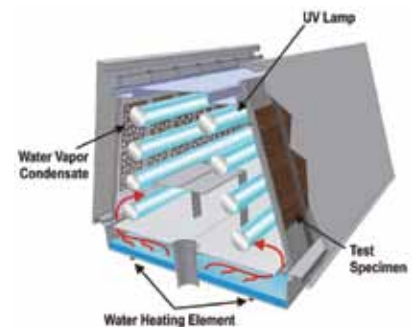

Recirculating Spray Water

A deionized water recirculation and filtration system is available for use with the UVTest in labs with limited deionized water availability. The deionized water recirculator saves deionized water and fits conveniently below the UVTest.





Standards

The UVTest meets or exceeds the following industry standards:

ASTM	D4329	D4587	D4799
	D5208	G151	G154
EN	927-6	1297	1898
	12224	13523-10	
ISO	4892-1	4892-3	11507
	11895	11997-2	
prEN	1062-4		
SAE	J2020		

This is a sample of global standards that can be met by this instrument. For more information on additional or specific standards, contact your local Atlas® representative. Standards are subject to change without notice. This might lead to the inclusion or exclusion of certain instruments.

UVTest Features

Fluorescent UV Lamps (8)	40 W UVA 340, UVB 313, UVA 351
Black Panel Temperature (BPT) Control	●
Door Safety and Over-temperature Shutoff	●
CE Compliance and UL & CSA Certified	●
Specimen Holders	●
Touch Screen Display	●
Irradiance Calibration Safety Access Ports	●
Recirculating Spray Water	■
Irradiance Control (340 nm, 313 nm, 351 nm)	■
Stacking Kit	■
Specimen Spray Nozzles (12)	■
Hand-held Irradiance Calibrator	■
Data Acquisition Program via Ethernet	■

● Standard ■ Optional

Specific Utility Requirements and Specifications for this instrument can be found on page 29 and SPD graphs on pages 9-10.

Common Applications

Geotextiles



Paints, Coatings and Pigments

Plastics



Photovoltaics

Wood Coatings



Other Applications:

Adhesives
Automotive Exteriors
Textiles



SC2000
Features a 3400 liter test chamber capacity.

SC600
Features a 600 liter test chamber capacity.

Solar Simulation Chambers

Simulating Indoor and Outdoor Conditions for Whole Components and Finished Products

The SC series is equipped with either MH (Metal Halide) or MHG (Metal Halide Global) lamps to achieve an accelerated simulation of indoor and outdoor weathering. The MHG lamp has the ability to vary output across a specific range and does not exhibit the energy peaks at certain wavelengths, which are found in the MH spectrum. These peaks can produce widely differing results in samples with corresponding spectral sensitivity. MH units are therefore preferred for heat load tests. All SC units are suitable for laboratory testing using simulated sunlight and the MHG models are the best solution for aging tests. The SC340, SC600, SC1000 and the SC2000 can be used as full-function climate chambers.

SolarClimatic Features and Benefits

- Spacious test chamber design offers four test capacities allowing testing of components with large surface areas (for example airbags) or even complete large components (for example instrument panels, bumpers, side panels, etc.)
- Influencing parameters such as global irradiation, temperature and humidity can be individually programmed
- Easily accessible communications and control units guarantee ease of use for the operator
- High performance program functions allow the design of very flexible test specifications to match the customer's individual testing needs

Standards

The SC series meets or exceeds the following industry standards:

BMW	PrV 306
DIN	75 220
GB/T	2423.24
IEC	68-2-5
ISO	9022-9 12097-2
MIL STD	810 G (Method 505.5)
VW	PV 1211

This is a sample of global standards that can be met by this instrument. For more information on additional or specific standards, contact your local Atlas® representative. Standards are subject to change without notice. This might lead to the inclusion or exclusion of certain instruments.



Features

	SC340	SC600	SC1000	SC2000
MH Wattage	1 x 1500	1 x 1500	2 x 1500	4 x 1500
MHG Wattage	1 x 1200	1 x 2500	1 x 2500	2 x 4000
Exposure Area (cm ²)	1,600	3,000	5,600	13,600
Test chamber volume (l)	340	600	1000	3400
Spectral distribution according to CIE No. 85 Table 4 (base) and DIN 75220, Table 1, Column 2/4 (shares)	●	●	●	●
Easy-to-use touch screen	●	●	●	●
Climate with/without irradiation	●	●	●	●
Control and display of irradiance, chamber temperature, humidity and dew point	●	●	●	●
Programmable heat-up and cool down speed	●	●	●	●
Swiveling operator panel	●	●	●	N/A
Operator Panel integrated into control module on front side	N/A	N/A	N/A	●
Microprocessor control	●	●	●	●
CE compliant	●	●	●	●
Insulated cover to expand temperature range	■	■	■	■
Misting equipment to expand climate possibilities	■	■	■	■
UV sensors: 280-320 nm/320-400 nm	■	■	■	■
Control of Black Standard Temperature	■	■	■	■
Black Standard Thermometer	■	■	■	■
Solar test sensor: 300-3000 nm	■	■	■	■
RS422/485 interface	■	■	■	■
Printer: 6-color, programmable	■	■	■	■
S!MPATT™ software for data acquisition	■	■	■	■

● Standard ■ Optional

Specific Utility Requirements and Specifications for each instrument can be found on page 30, SPD graphs on pages 9-10, Filter Combinations on page 7.

Temperature and Humidity Control

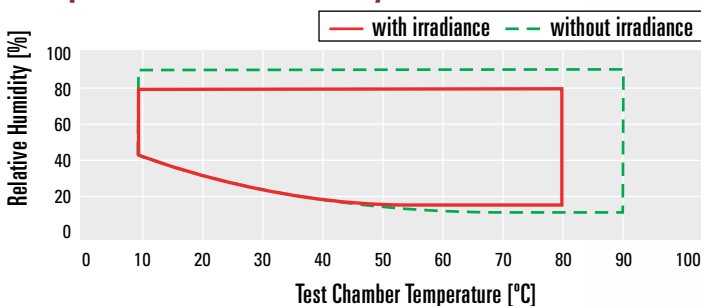





Operable ranges of humidity control at various test chamber temperatures (under normal laboratory conditions).

Common Applications:

Automotive 3D
Plastic Components
Chemicals
Electronics
MilAero
Photovoltaics
Roofing
Window Units





	 Ci5000 Weather-Ometer®	 Ci4000 Weather-Ometer	 Ci3000+ Weather-Ometer	 Ci3000+ Fade-Ometer®
Light Source	12000 W Water-Cooled Xenon Arc Lamp	6500 W Water-Cooled Xenon Arc Lamp	4500 W Water-Cooled Xenon Arc Lamp	4500 W Water-Cooled Xenon Arc Lamp
Minimum Guaranteed Lamp Life (at one sun level)	2000 Hours	2000 Hours	2000 Hours	2000 Hours
Filters	Interchangeable Inner and Outer (see page 6 for a complete list)	Interchangeable Inner and Outer (see page 6 for a complete list)	Interchangeable Inner and Outer (see page 6 for a complete list)	Interchangeable Inner and Outer (see page 6 for a complete list)
Irradiance Control	Automatic single point control at 340 nm or 420 nm or 300-400 nm; optional monitoring at 2nd point	Automatic single point control at 340 nm or 420 nm or 300-400 nm; optional monitoring at 2nd point	Automatic single point control at 340 nm or 420 nm or 300-400 nm; optional monitoring at 2nd point	Automatic single point control at 340 nm or 420 nm or 300-400 nm; optional monitoring at 2nd point
Light Monitor	Smart Light™ Monitor	Smart Light Monitor	Smart Light Monitor	Smart Light Monitor
Humidity Control (RH)	Automatic	Automatic	Automatic	Automatic
Humidity Range	Light Cycle: 10-75% (Dependent on Temp) Dark Cycle: Up to 100%	Light Cycle: 10-75% (Dependent on Temp) Dark Cycle: Up to 100%	Light Cycle: 10-75% (Dependent on Temp) Dark Cycle: Up to 100%	Light Cycle: 10-75% (Dependent on Temp)
Temperature Control	Automatic	Automatic	Automatic	Automatic
Black Panel or Black Standard Temperature Range	BPT 40-110° C; BST 40-120° C	BPT 40-110° C; BST 40-120° C	BPT 40-110° C; BST 40-120° C	BPT 40-110° C; BST 40-120° C
Simultaneous Control of BPT or BST and Chamber Temperature	Standard	Standard	Standard	Standard
Dual BPT/BST Control	Optional	Optional	Optional	Optional
Specimen Rack Type	3 Tier/Custom Available	3 Tier/Custom Available	Single Tier/2 Tier	Single Tier/2 Tier
Total Exposure Area	11000 cm ² (1705 in ²)	6500 cm ² (1008 in ²)	2188 cm ² (339 in ²)/3422 cm ² (530 in ²)	2188 cm ² (339 in ²)/3422 cm ²
Specimen Holders	See Page 31	See Page 31	See Page 31	See Page 31
Electric	400/480 V, 3 Phase, 3 Wire, 50/60 Hz, 60 A; or 400 V, 3 Phase, 50 Hz, 65 A	200/250 V, 3 Phase, 3 Wire, 50/60 Hz, 52 A; or 200/250 V, 3 Phase, 4 Wire, 50 Hz, 42 A	200/250 V, 1 or 3 Phase, 50/60 Hz, 47/57 A; or 400/230 V, 3 Phase, 4 Wire, 50 Hz, 38 A	200/250 V, 1 or 3 Phase, 50/60 Hz, 47/57 A; or 400/230 V, 3 Phase, 4 Wire, 50 Hz, 38 A
HVAC - MJ/h (BTU/h) (Max.)	64.22 MJ/h (60870 BTU/h, 800 CFM)	41.36 MJ/h (39203 BTU/h, 450 CFM)	26.06 MJ/h (24703 BTU/h, 275 CFM)	26.06 MJ/h (24703 BTU/h, 275 CFM)
Compressed Air	0.11 m ³ /min (4 CFM max.) @ 552 kPa (80 psi)	0.11 m ³ /min (4 CFM max.) @ 552 kPa (80 psi)	0.11 m ³ /min (4 CFM max.) @ 552 kPa (80 psi)	0.11 m ³ /min (4 CFM max.) @ 552 kPa (80 psi)
Pressure	124-207 kPa (18-30 PSI)	124-207 kPa (18-30 PSI)	124-207 kPa (18-30 PSI)	124-207 kPa (18-30 PSI)
Humidification	0.2 l/min	0.2 l/min	0.12 l/min	0.12 l/min
Specimen Spray	0.2 l/min	0.2 l/min	0.07 l/min	N/A
Rack Spray	0.2 l/min	0.2 l/min	0.07 l/min	N/A
Physical Dimension (WxDxH)	160 cm x 130 cm x 198 cm	127 cm x 102 cm x 198 cm	97 cm x 84 cm x 183 cm	97 cm x 84 cm x 183 cm
Footprint	212 cm x 293 cm including access area	180 cm x 272 cm including access area	146 cm x 256 cm including access area	146 cm x 256 cm including access area
Floor Weight	807 kg (1780 lb)	585 kg (1290 lb)	410 kg (905 lb)	410 kg (905 lb)
Standards	AATCC TM 16 TM 16E-1998 TM 169 ASTM D2565 D6695 E1596 G151 G155 Ford FLTM BO 116-01 GME 60292 GB/T 1865 8427 13492 16422.2 GMW 3414TM 14162 ISO 105-B02 105-B04 105-B06 3917 4892-1 4892-2 11341 12040 JASO M 346 MIL STD 810 G Peugeot/Citroen D27 1389 SAE J1885 J1960 J2412 J2527 621-429 621-430 75202 VDA PV 1303 PV 3929 PV 3930	AATCC TM 16 TM 16E-1998 TM 169 ASTM D2565 D6695 E1596 G151 G155 Ford FLTM BO 116-01 GME 60292 GB/T 1865 8427 13492 16422.2 GMW 3414TM 14162 ISO 105-B02 105-B04 105-B06 3917 4892-1 4892-2 11341 12040 JASO M 346 MIL STD 810 G Peugeot/Citroen D27 1389 SAE J1885 J1960 J2412 J2527 621-429 621-430 75202 VDA PV 1303 PV 1306 PV 3929 PV 3930	AATCC TM 16 TM 16E-1998 TM 169 ASTM D2565 D6695 E1596 G151 G155 GME 60292 GB/T 1865 8427 13492 16422.2 GMW 3414TM 14162 ISO 105-B02 105-B04 105-B06 3917 4892-1 4892-2 11341 12040 JASO M 346 Marks & Spencer C9 C9A MIL STD 810 G Peugeot/Citroen D27 1389 SAE J2412 J2527 VDA 75202 VW PV 1303 PV 3929 PV 3930	AATCC TM 16 TM 16E-1998 ASTM D2565 D6695 E1596 G151 G155 GME 60292 GB/T 8427 GMW 3414TM 14162 ISO 105-B02 105-B06 12040 JASO M 346 Marks & Spencer C9 C9A Renault D47 1431 VDA 75202 VW PV 1303 PV 3929

This is a sample of global standards that can be met by this instrument. For more information on additional or specific standards, contact your local Atlas representative.

Standards are subject to change without notice. This might lead to the inclusion or exclusion of certain instruments.

Xenotest® Comparison Chart

Accelerated Weathering Products

Xenotest Beta+ / Beta+ FD	Xenotest Alpha+	Xenotest 150S+	Xenotest 220/220+
3x 2200 W Air-Cooled Xenon Arc Lamp	2200 W Air-Cooled Xenon Arc Lamp	2200 W Air-Cooled Xenon Arc Lamp	2200 W Air-Cooled Xenon Arc Lamp
1500 Hours	1500 Hours	1500 Hours	1500 Hours
Non-aging (see page 7)	Non-aging, IR absorption (see page 7)	IR absorption (see page 7)	Non-aging (see page 7)
Automatic control at 300-400nm	Automatic control at 300-400nm	Automatic control of lamp power	Automatic control at 300-400nm
On-rack XENOSENSIV®	On-rack XENOSENSIV	N/A (On-rack XENOSENSIV optional)	On-rack XENOSENSIV
Automatic / N/A	Automatic	Automatic	Automatic
Light Cycle*: 10-70% Dark Cycle: Up to 100%	Light Cycle*: 10-70% Dark Cycle: Up to 100%	Light Cycle*: 10-70% Dark Cycle: Up to 100%	Light Cycle*: 20-85% Dark Cycle: Up to 100%
*Light cycle values are measured under 100% burner intensity and 2000 RPM			
Automatic	Automatic	Automatic	Automatic
BST 40-130° C	BST 40-130° C	BST 40-130° C	BST 40-100° C
Standard (BST)	Standard (BST)	N/A	Standard (BST)
N/A	N/A	N/A	N/A
1- or 2-Tier	1-Tier	1-Tier	1-Tier
4000 cm²	1320 cm²	1320 cm²	2310 cm²
See Page 32	See Page 32	See Page 32	See Page 32
400 V±10%, 50/60 Hz (3, N, PE) AC CEE (32 A, 3 pole 6h)	230 V±10%, 50/60 Hz (1, N, PE) AC or (2, PE) AC CEE (32 A, 3 pole 6h)	230 V±10%, 50/60 Hz (1, N, PE) AC or (2, PE) AC CEE (32 A, 3 pole 6h)	230 V±10%, 50/60 Hz (1, N, PE) AC or (2, PE) AC CEE (32 A, 3 pole 6h)
43.26 MJ/h	18.00 MJ/h	18.00 MJ/h	18.00 MJ/h
not required	not required	not required	not required
not required	not required	not required	not required
0.07 l/min / N/A	0.03 l/min / N/A	2-3 l/day (@ ISO 105-B02)	2-3 l/day (@ ISO 105-B02)
0.7 l/min / N/A	0.7 l/min	0.7 l/min	N/A
0.7 l/min / N/A	N/A	N/A	N/A
90 cm x 120 cm x 180 cm 90 cm x 200 cm* x 228 cm* *(including Air circulation loop)	90 cm x 78 cm x 180 cm	90 cm x 78 cm x 180 cm	90 cm x 78 cm x 180 cm
190 cm x 220 cm 190 cm x 300 cm* *(including service area)	190 cm x 178 cm including service area	190 cm x 178 cm including service area	190 cm x 178 cm including service area
400 kg (882 lb) / 390 kg (860 lb)	280 kg (615 lb)	280 kg (615 lb)	280 kg (615 lb)
AATCC TM 169 ASTM D2565 D6695 E1596 G151 G155 DIN EN513 GME 60292 GB/T 1865 8427 13492 16422.2 GMW 3414 14162 ISO 105-B02 105-B04 105-B06 3917 4892-1 4892-2 11341 12040 JASO M 346 RAL-GZ 716/1 VDA 75202 VW PV 1303 PV 1306 PV 3929 PV 3930	AATCC TM 16 TM 16H-1998 TM 169 ASTM D2565 D6695 E1596 G151 G155 GME 60292 GB/T 1865 8427 13492 16422.2 GMW 3414 14162 ISO 105-B02 105-B04 105-B06 3917 4892-1 4892-2 11341 12040 JASO M 346 Marks & Spencer C9 C9A SAE J2019 J2212 VDA 621-429 621-430 75202 VW PV 1303	AATCC TM 16H-1998 TM 169 ASTM D2565 D6695 E1596 G151 G155 GB/T 8427 ISO 105-B02 105-B04 12040 JASO M 346 Marks & Spencer C9 C9A	AATCC TM 16 (option 3) TM169 (option 2&3) GB/T 8427 ISO 105-B02 Marks & Spencer C9 C9A

- Light Source
- Minimum Guaranteed Lamp Life (at one sun level)
- Filters
- Irradiance Control
- Light Monitor
- Humidity Control (RH)
- Humidity Range
- Temperature Control (CHT)
- Black Panel or Black Standard Temperature Range
- Simultaneous Control of BPT or BST and CHT
- Dual BPT/BST Control
- Specimen Rack Type
- Total Exposure Area
- Specimen Holders
- Electric
- HVAC - MJ/h (BTU/h)
- Compressed Air
- Pressure
- Humidification
- Specimen Spray
- Rack Spray
- Physical Dimension (WxDxH)
- Footprint
- Floor Weight
- Standards

This is a sample of global standards that can be met by this instrument. For more information on additional or specific standards, contact your local Atlas® representative.

Standards are subject to change without notice. This might lead to the inclusion or exclusion of certain instruments.

	SUNTEST XXL/XXL+	SUNTEST XLS+	SUNTEST CPS/CPS+	UVTest
Light Source	3 x 2100 W Air-Cooled Xenon Arc Lamp	1700 W Air-Cooled Xenon Arc Lamp	1500 W Air-Cooled Xenon Arc Lamp	8 x 40 W Fluorescent Lamps
Minimum Guaranteed Lamp Life (at one sun level)	1500 Hours	1500 Hours	1500 Hours	N/A
Filters	Auxiliary Filter System (see page 8 for a complete list)	Auxiliary Filter System (see page 8 for a complete list)	Auxiliary Filter System (see page 8 for a complete list)	N/A
Irradiance Control	Automatic at 340 nm, 420 nm or 300-400 nm	Automatic control at 340 nm, 300 - 400 nm, 300 - 800 nm or LUX	Automatic control at 300-800 nm	Automatic control at 320 nm or 340 nm
Light Monitor	Built-in SUNSENSIV sensors	Built-in SUNSENSIV sensors	CPS+: built-in SUNSENSIV sensors	4 Smart Light™ Monitors
Humidity Control (RH)	Automatic	N/A	N/A	N/A
Humidity Range	Light Cycle*: 40-80% Dark Cycle: Up to 95%	N/A	N/A	N/A
*Light cycle values are measured under 100% burner intensity and 2000 RPM				
Temperature Control	Up to 70° C	N/A	N/A	Automatic ±2° C
Black Panel or Black Standard Temperature Range	BPT 45-95° C BST 45-100° C	BPT 45-95° C BST 45-100° C	BST 35-100° C	BPT 30-90° C
Simultaneous Control of BPT or BST and Chamber Temperature	Standard	N/A (Monitoring of chamber temperature only)	N/A (CPS+: Monitoring of chamber temperature only)	N/A
Dual BPT/BST Control	N/A	N/A	N/A	N/A
Specimen Rack Type	Flatbed	Flatbed	Flatbed	2 "near" vertical exposure areas
Total Exposure Area	3000 cm ² (478 in ²)	1100 cm ² (171 in ²)	560 cm ² (86 in ²)	5175 cm ² (828 in ²)
Specimen Holders	See Page 32	See Page 32	N/A	(23) 7.5 cm x 30 cm; or (15) 10 cm x 30 cm
Electric	400 V± 10%, 50/60 Hz; 200-400 V 50/60 Hz 3 Phase/3 Wire Other voltages available upon request	200-240 V, 50/60 Hz (1, N, PE); CEE (32 A, 3 pole 6h)	200-240 V, 50/60 Hz (1, N, PE); CEE (16 A, 3 pole 6h)	120 V, 1 Phase, 50/60 Hz, 12 A; or 230 V, 1 Phase, 50/60 Hz, 8 A
HVAC - MJ/h (BTU/h) (Max.)	35.0 MJ/h (33175 BTU/h)	12.96 MJ/h (12287 BTU/h)	7.561 MJ/h (7166 BTU/h)	N/A
Compressed Air	N/A	N/A	N/A	N/A
Deionized Water Flowrate	N/A	N/A	N/A	193 kPa (28 psi)
Pressure Humidification	XXL+: 4 l/h max.	N/A	N/A	N/A
Specimen Spray	XXL+: 0.31 l/min	Optional Specimen Spray & Immersion	Optional Immersion	7.2 l/min
Rack Spray	N/A	N/A	N/A	N/A
Physical Dimension (WxDxH)	90 cm x 91 cm x 172 cm	90 cm x 54 cm x 62 cm	78 cm x 35 cm x 35 cm	135 cm x 51 cm x 155 cm
Footprint	335 cm x 315 cm	150 cm x 170 cm	100 cm x 95 cm	135 cm x 51 cm
Floor Weight	XXL: 280 kg (615 lb) XXL+: 290 kg (638 lb)	90 kg (176 lb)	29 kg (64 lb)	129 kg (285 lb)
Standards	AATCC TM16 TM169 ASTM C1442 C1501 D6695 G151 G155 EPA/ASTM GB/T 1865 8427 13492 16422.2 ISO 4049 4665 4892-1 4892-2 7491 11341 11431 11979-5 18909 VW PV 1306 PV 3929 PV 3930	ASTM C1442 C1501 D3424 D5071 D6695 G151 G155 EPA/ASTM ICH Guideline Q1B Q5C GB/T 8427 16422.2 ISO 4049 4892-1 4892-2 7491 10977 11431 11979-5	ASTM C1442 C1501 D3424 D5071 D6695 G151 G155 COLIPA In vitro determination of UVA protection EPA/ASTM ICH GB/T 8427 16422.2 Guideline Q1B Q5C ISO 4049 4892-1 4892-2 7491 10977 11431 11979-5 VW PV 1323	ASTM D4329 D4587 D4799 D5208 G151 G154 EN 927-6 1297 1898 12224 13523-10 ISO 4892-1 4892-3 11507 11895 11997-2 JIS prEN D0205 SAE 1062-4 J2020

This is a sample of global standards that can be met by this instrument. For more information on additional or specific standards, contact your local Atlas® representative.

Standards are subject to change without notice. This might lead to the inclusion or exclusion of certain instruments.

SolarClimatic Comparison Chart

Accelerated Weathering Products

SolarClimatic 2000		SolarClimatic 1000		SolarClimatic 600		SolarClimatic 340	
4 x 1500 W MH lamps 2 x 4000 W MHG lamps		2 x 1500 W MH lamps 2500 W MHG lamps		1500 W MH lamps 2500 W MHG lamps		1500 W MH lamps 1200 W MHG lamps	
N/A		N/A		N/A		N/A	
Outdoor/Indoor (see page 7 for a complete list)		Outdoor/Indoor (see page 7 for a complete list)		Outdoor/Indoor (see page 7 for a complete list)		Outdoor/Indoor (see page 7 for a complete list)	
Adjustable irradiance from 800-1200 W/m ² (280-3000 nm) – for MHG Models only		Adjustable irradiance from 800-1200 W/m ² – for MHG Models only		Adjustable irradiance from 800-1200 W/m ² (280-3000 nm) – for MHG Models only		Adjustable irradiance from 800-1200 W/m ² (280-3000 nm) – for MHG Models only	
N/A		N/A		N/A		N/A	
Automatic		Automatic		Automatic		Automatic	
10-80% with irradiation; 10-90% without irradiation		10-80% with irradiation; 10-90% without irradiation		10-80% with irradiation; 10-90% without irradiation		10-80% with irradiation; 10-90% without irradiation	
Automatic (chamber)		Automatic (chamber)		Automatic (chamber)		Automatic (chamber)	
N/A		N/A		N/A		N/A	
N/A (automatic control of chamber temperature only; BST optional)		N/A (automatic control of chamber temperature only; BST optional)		N/A (automatic control of chamber temperature only; BST optional)		N/A (automatic control of chamber temperature only; BST optional)	
N/A		N/A		N/A		N/A	
Customer Built		Customer Built		Customer Built		Customer Built	
13600 cm ² (2108 in ²)		5600 cm ² (868 in ²)		3000 cm ² (465 in ²)		1600 cm ² (248 in ²)	
Chamber Volume: (WxDxH) 200 cm x 115 cm x 151 cm		Chamber Volume: (WxDxH) 110 cm x 95 cm x 95 cm		Chamber Volume: (WxDxH) 80 cm x 80 cm x 95 cm		Chamber Volume: (WxDxH) 58 cm x 76.5 cm x 75 cm	
400 V ±10% (3, N, PE) AC, 50 Hz (60 Hz version or other voltages on request)		400 V ±10% (3, N, PE) AC, 50 Hz (60 Hz version or other voltages on request)		400 V ±10% (3, N, PE) AC, 50 Hz (60 Hz version or other voltages on request)		400 V ±10% (3, N, PE) AC, 50 Hz (60 Hz version or other voltages on request)	
N/A		N/A		N/A		N/A	
N/A		N/A		N/A		N/A	
N/A		N/A		N/A		N/A	
N/A		N/A		N/A		N/A	
Industrial Water		Deionized Water		Deionized Water		Deionized Water	
N/A		N/A		N/A		N/A	
350 cm x 145 cm x 290 cm		139 cm x 185 cm x 255 cm		108.5 cm x 165.5 cm x 255 cm		86.5 cm x 159.5 cm x 218 cm	
475 cm x 280 cm		475 cm x 280 cm		165 cm x 350 cm		165 cm x 350 cm	
1550 kg (3418 lb)		775 kg (1709 lb)		675 kg (1488 lb)		565 kg (1246 lb)	
BMW	PrV 306	BMW	PrV 306	BMW	PrV 306	BMW	PrV 306
DIN	75 220	DIN	75 220	DIN	75 220	DIN	75 220
GB/T	2423.24	GB/T	2423.24	GB/T	2423.24	GB/T	2423.24
IEC	68-2-5	IEC	68-2-5	IEC	68-2-5	IEC	68-2-5
ISO	9022-9 12097-2	ISO	9022-9 12097-2	ISO	9022-9 12097-2	ISO	9022-9 12097-2
MIL STD	810 G (Method 505.5)	MIL STD	810 G (Method 505.5)	MIL STD	810 G (Method 505.5)	MIL STD	810 G (Method 505.5)
VW	PV 1211	VW	PV 1211	VW	PV 1211	VW	PV 1211

- Light Source
- Minimum Guaranteed Lamp Life (at one sun level)
- Filters
- Irradiance Control
- Light Monitor
- Humidity Control (RH)
- Humidity Range
- Temperature Control
- Black Panel or Black Standard
- Temperature Range
- Simultaneous Control of BPT or BST and Chamber Temperature
- Dual BPT/BST Control
- Specimen Rack Type
- Total Exposure Area
- Specimen Holders
- Electric
- HVAC - MJ/h (BTU/h) (Max.)
- Compressed Air
- Pressure
- Humidification
- Specimen Spray
- Rack Spray
- Physical Dimension (WxDxH)
- Water Flowrate
- Footprint
- Floor Weight
- Standards

This is a sample of global standards that can be met by this instrument. For more information on additional or specific standards, contact your local Atlas® representative.

Standards are subject to change without notice. This might lead to the inclusion or exclusion of certain instruments.



Holder Type	Description	Applications	Maximum Size mm (in) WxHxD	Exposure Size mm (in) WxH	Instrument	Rack Capacity
 SL-3T Single exposure window with spring clip back Part Number 19163900	General purpose holder for exposure of thin specimens	Textiles, plastic film, automotive interior	67 x 145 x 3 (2.6 x 5.7 x 0.1)	50 x 121 (2.0 x 4.7)	Ci3000+ Ci4000 Ci5000	20 68 111
 SL-3T with Glass Single exposure window with glass and adjustable back Part Number 07303900	Exposure through secondary filter to closely simulate end-use environment	Textiles, paper, plastic film, carpet, automotive interior	67 x 145 x 15 (2.6 x 5.7 x 0.6)	50 x 121 (2.0 x 4.7)	Ci3000+ Ci4000 Ci5000	20 68 111
 CD-3T Three exposure windows with spring clip back Part Number 20215700	General purpose holder with three exposure windows for thin specimens	Textiles, paper, plastic film, automotive interior	67 x 145 x 3 (2.6 x 5.7 x 0.1)	3 windows: 38 x 50 (1.5 x 2.0)	Ci3000+ Ci4000 Ci5000	20 68 111
 CD-3T with Glass Three exposure windows with glass, spring clip back Part Number 07303800	Exposure through secondary filter to closely simulate end-use environment	Textiles, paper, plastic film, wood, automotive interior	67 x 145 x 15 (2.6 x 5.7 x 0.6)	3 windows: 38 x 50 (1.5 x 2.0)	Ci3000+ Ci4000 Ci5000	20 68 111
 RD-3T Single window or 3-window exposure with "bulldog" clip holder Part Number 20017900	Versatile holder to accommodate a range of specimen widths and thicknesses	Coatings on various substrates, plastics, textiles, glass	77 x 152 x 10 (3.0 x 6.0 x 0.4)	57 x 134 (2.3 x 5.3)	Ci3000+ Ci4000 Ci5000	20 68 111
 TEX-3T with Mask Single exposure window with mask, adjustable Part Number 19186700	Holder with masked exposure and adjustable back to allow for thick sample	Textiles, foam, foam-backed materials	45 x 134 x 12 (1.7 x 5.3 x 0.5)	19 x 119 (0.7 x 4.7)	Ci3000+ Ci4000 Ci5000	29 104 170
 Panel Holder Part Number 19188501	Holds 76 x 152 (3 x 6) panels for exposure tests of coatings	Coatings, rigid plastic, wood	76 x 152 x 9 (3.0 x 6.0 x 0.37)	76 x 146 (3.0 x 5.7)	Ci3000+ Ci4000 Ci5000	16 56 87
 Drop-in Specimen Bar Holder Part Number 19184600	Holds vertical specimen bars	Plastics	77 x 144 x 3 (3.0 x 5.6 x 0.1)	76 x 125 (3.0 x 4.9)	Ci3000+ Ci4000 Ci5000	15 50 84

This chart is a representative sample of specimen holders available for a variety of Atlas® instruments. For specific information about specimen holders that best meet your needs, please contact your local Atlas representative.



Specimen Holders

Accelerated Weathering Products

Rack Capacity	Instrument	Exposure Size mm (in) WxH	Maximum Size mm (in) WxHxD	Applications	Description	Holder Type
11	Xenotest® Alpha+ Xenotest 150 S+	121 x 35 (4.8 x 1.4)	135 x 45 (5.3 x 1.8)	Textiles, plastics, coatings, paper	Holds specimen up to 3 mm thick	Regular Specimen Holder Part Number 56075142
11	Xenotest Alpha+ Xenotest 150 S+	121 x 35 (4.8 x 1.4)	135 x 45 (5.3 x 1.8)	Carpets, foam, foam-backed materials, thick panels	Holds specimen up to 15 mm thick	Specimen Holder for Thick Specimens Part Number 56077987
only 1 needed (replaces one holder)	Xenotest Alpha+ Xenotest 150 S+	—	135 x 45 (5.3 x 1.8)	Blue Scale fabric	Holder for Blue Scale fabric during weathering tests	Specimen Holder for Blue Scale Part Number 56050873
16	Xenotest Beta+	295 x 70 (11.6 x 2.8)	310 x 80 (12.2 x 3.2)	Textiles, plastics, coatings, paper, window profiles	Holds specimen up to 10 mm thick	Standard Specimen Holder (including back plate) Part Number 56076543
16	Xenotest Beta+	90 x 58 (3.5 x 2.3)	100 x 68 (3.9 x 2.7)	Textiles, plastics, coatings, paper	Holds 3 specimens up to 10 mm thick, fixed by a back plate and a cover mask	Special Specimen Holder, 3 Segments Part Number 56076699
28 19	Xenotest Beta+ Xenotest 220/220+	121 x 35 (4.8 x 1.4)	135 x 45 (5.3 x 1.8)	Carpet, foam- backed textiles	Holds 2 specimens up to 10 mm thick, fixed by 2 cover masks	Special Specimen Holder, 2 Segments Part Number 56076700
28 19	Xenotest Beta+ Xenotest 220/220+	121 x 35 (4.8 x 1.4)	135 x 45 (5.3 x 1.8)	Textiles, paper, leather	Holds 2 samples up to 3 mm thick, fixed by 2 cover masks	Specimen Holder Standard, 2 Segments Quick-insertion Part Number 56079776
28 19	Xenotest Beta+ Xenotest 220/220+	270 x 45 (10.6 x 1.8)	320 x 48 (12.6 x 1.9)	Technical textiles	Holds 1 specimen up to 3 mm thick	Specimen Holder Special TS, 1 Segment Quick-insertion, Part Number 56079797
only 1 needed (replaces one holder)	Xenotest 220/220+	—	135 x 45 (5.3 x 1.8)	Blue Scale fabric	Holds Blue Scale fabric for weathering tests	Specimen Holder for Blue Scale (Special holder kit, 2 Segments) Part Number 56078036
15	SUNTEST® XLS+	121 x 35 (4.8 x 1.4)	135 x 45 (5.3 x 1.8)	Plastics, coatings, paper, leather	General purpose holder for various materials	Set of 15 Specimen Trays Part Number 56079636
34	SUNTEST XXL/XXL+	121 x 35 (4.8 x 1.4)	135 x 45 (5.3 x 1.8)	Plastics, coatings, paper	General purpose holder for various materials	Set of Five Specimen Trays for 7 Specimens Part Number 56079259
8	SUNTEST XXL/XXL+	295 x 70 (11.6 x 2.8)	310 x 80 (12.2 x 3.2)	Plastics, coatings, paper	General purpose holder for various materials	Set of Two Specimen Trays for 4 Specimens Part Number 56079261

This chart is a representative sample of specimen holders available for a variety of Atlas® instruments. For specific information about specimen holders that best meet your needs, please contact your local Atlas representative.

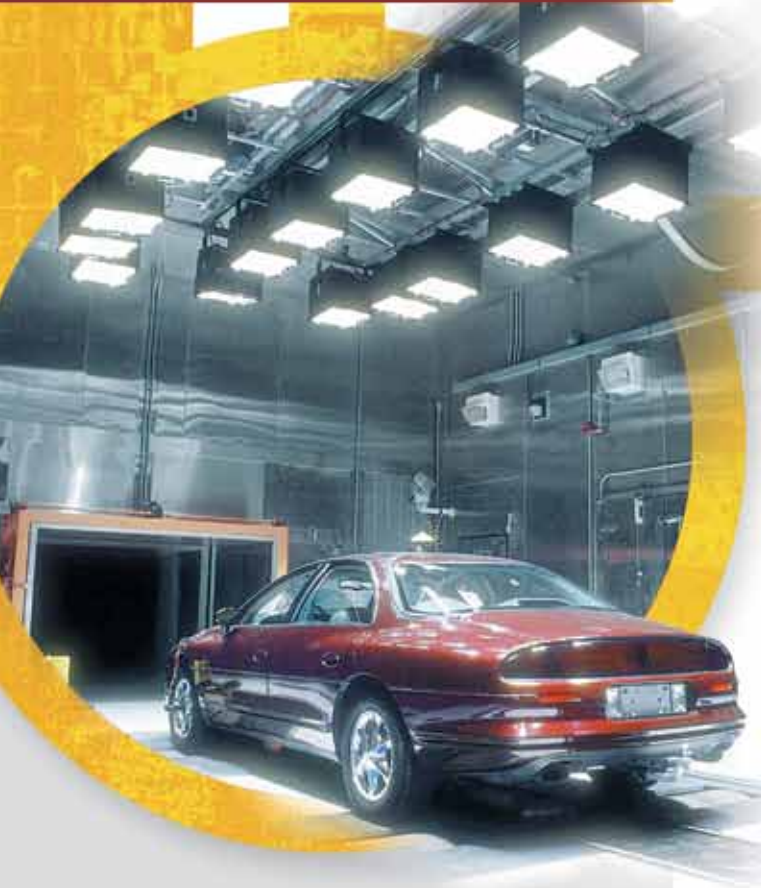

SolarConstant and High-Speed Lighting

Custom-Designed Solar Simulation Systems

Atlas® solar simulation systems such as walk-in chambers or full-scale test facilities are custom designed. These full-scale test facilities use a series of highly-coordinated metal halide lights to provide effective solar energy to meet the demanding testing needs of many industries, for example the automotive or solar energy industry.

A Proven Light Source

The Atlas radiation system uses special Metal Halide Global (MHG) lamps and glass filters to create a spectral distribution very close to natural sunlight. The combination of lamp, reflectors and filter offers high irradiance efficiency and superior spatial uniformity critical for solar simulation testing.

Solar Simulation – with SolarConstant

An established application of Atlas radiation systems is the simulation of the solar spectral emission or total radiation (direct solar plus sky radiation). These solar simulation units – SolarConstant – are used to determine the aging behavior of organic materials, to optimize HVAC systems and to examine thermal effects. Solar simulation can also be an important tool in the development of solar energy conversion systems. The Atlas SolarConstant series offers adaptable systems to meet the requirements of various test configurations and fulfills applications that require or demand effective solar simulation.

Optimal Performance Power Supply

To achieve the best performance, an electronic power supply (EPS-Module) drives the lamp with square-wave current. This reduces modulation of radiation to less than +/-1%, controls intensity and offers a stabilized power output even when incoming power varies. In addition, it provides the lamp optimal conditions for operation, extending the lamp life.

Standards

Atlas provides SolarConstant systems specifically designed to comply with established test methods, such as:

DIN	75220
EPA	CFR 40 part 86
MIL-STD	810
SAE	J2777

This is a sample of global standards that can be met by this instrument. For more information on additional or specific standards, contact your local Atlas representative.

Standards are subject to change without notice. This might lead to the inclusion or exclusion of certain instruments.

Automated Positioning and Control System

To effectively simulate various natural solar conditions, a mechanical positioning system is used. This enables motorized movement of the solar array within all axes for easy adaptation to various test configuration or to simulate natural solar day or seasonal solar cycles. The control can be a manual push button or integrated into the PC-based SolarSoft system control program. SolarSoft provides automated control of radiation, along with effective simulation of various sun positions in the sky – or automated rotation, tilting and positioning of lamp groups and frames. Positioning systems are often unique to the application and test facility. Atlas® will work with you to define the SolarConstant mounting system that will work best for your application.

Customized Solutions

Atlas solar simulation systems are custom-made to meet your testing objectives. The SolarConstant and other specialized radiation systems are modular in nature and offer a large variety of configurations, allowing system design flexibility. The use of various sized radiation units, EPS-Modules, mounting systems and the flexibility of SolarSoft, allows Atlas to design a cost-effective solution that fulfills your solar simulation requirements.

Planning, Design and Production

A critical part in the development of any technical lighting solution is a detailed knowledge of the application and the related objectives. Therefore, the consultation with the customer is the first step of each planning process. This close cooperation to accurately define the test application assures that the final design of the system will satisfy the test objectives. Atlas provides customized consultation, acquires specifications and investigates alternative solutions and techniques. Atlas lighting solutions offer adaptable systems to meet the requirements of various test configurations and fulfill applications that require or demand effective solar simulation.

To find the best solutions for different requirements, Atlas uses computer-aided design and measurement systems along with various instruments to analyze the relevant radiation and light sources. Experts in the field of radiation sources, optics, power supplies, computer integration and other important engineering fields are effectively utilized as part of the Atlas design team structure.





Lab Corrosion Testing Equipment

Innovative Lab Corrosion Testing

Manufacturers routinely test individual components, subassemblies, randomly selected production pieces and finished goods. Suppliers to the automotive and other industries must perform validation testing for corrosion resistance. Governments and consumer advocate associations perform lab corrosion tests to determine value, consumer safety, contractual and regulatory compliance, and military specifications.

Tests are often selected because they replicate the 'worst case' environmental conditions that cause corrosion. This provides data that helps assess the probability of material degradation in the real world. Many environmental conditions can be replicated and automatically cycled in an Atlas® lab corrosion testing cabinet.

Depending on the sophistication of the selected test method, Atlas has a cabinet designed to provide accurate, repeatable results. All Atlas lab corrosion testing cabinets can be optionally equipped with:

- High-profile for larger samples or low-profile for easier sample access
- Pass-through electrical or mechanical ports to test samples under load
- External Condensate Collection System
- Spare Parts Kit and Start-up Kit
- Air-assisted Cover Lifters
- Wide variety of holders for just about any size and shape of sample

Atlas SF

Still very popular and most often used for quick determination of corrosion resistance, SF cabinets are designed for ASTM B117 and similar traditional salt fog (spray) and humidity tests.

- Standard sizes from 420 l to 3680 l / 15 ft³ to 130 ft³
- Waist level access at no extra charge
- Double-wall steel cabinet, clear cover
- Test Temperature to 50° C



CCX



BCX



SF



Walk-in



Atlas® BCX

Designed for Basic Cyclic testing, which automatically switches from Fogging to Dry-off conditions. With installed optional upgrades, can also provide Gas Injection, Direct Spray (impingement) of sample surfaces, and High Temperature (71° C).

- Standard sizes from 565 l to 3115 l / 20 ft³ to 110 ft³
- Fiberglass™ construction – durable, non-corrosive, non-magnetic, non-conductive
- Clear cover (BCX9000 has opaque polypropylene cover)
- Design provides maximum testing volume with minimum floor space
- Test Temperature to 55° C

Atlas CCX

The most advanced, versatile lab corrosion testing cabinets available in the world. The Atlas CCX is capable of replicating and automatically cycling between more environmental conditions than any other cabinet. The sophistication of controls and engineered design provides exacting performance to test standards from around the world – ensuring repeatability, reproducibility and correlation to real world environments.

Advanced lab corrosion testing cabinets are more likely to provide the materials engineer with closer correlation of test results to outdoor environments, thereby allowing greater confidence in design and materials selection.

- Standard sizes from 565 l to 3115 l / 20 ft³ to 110 ft³
- Fiberglass™ construction – durable, non-corrosive, non-magnetic, non-conductive
- Clear cover (CCX9000 has opaque polypropylene cover)
- Design provides maximum testing volume with minimum floor space
- Test temperature to 71° C

Optional Upgrades to CCX:

- Premium Computer Controls
- Controlled/Adjustable RH
- High Temp to 90° C
- Low Temp to -30° C
- Immersion
- Direct Spray
- Gas Injection

Common Applications

Photovoltaics



Automotive

Electronics/
Telecommunications



Marine Craft

Military/Aerospace



Steel Structures

Other Applications:

Appliances
Architectural
Aviation
Fasteners
Transportation



SF Standards

ABNT NBR	8094	8095	
ASTM	B117	B368	B380
	D1735	D2247	G85 (Annexes 1-4)
DIN	50017	50021	
Ford	BI-103-01		
GM	4298P	4465P	
ISO	7253	9227	11997
JIS	Z2371		
MIL STD	810G (Method 509.5)	883 (Method 1009.8)	
TIA/EIA	455-16A		
Other	Water Fog	Acetic Acid	
Options	CASS	Corrodote	

BCX Standards —

All SF Standards Plus:

ASTM	D5894	G85 (Annexes 1, 2, 5)
ISO	11997-1	
VDA	621-415	
Other	Direct Spray	Wet/Dry Cyclic
Options	Prohesion™	Gas Injection



Computer Controlled Cycles

CCX optional computer controlled cycles include Immersion, Controlled Humidity, Freezing/Cooling, Very High/Very Low Temperature and Spray.

CCX Standards —

All SF and BCX Standards Plus:

ASTM	G85 (Annexes 3, 4)	
Ford	BI-123-01	CETP L-467
GM	9540P	GMW 14872
IEC	60068-2-52 part 2	
JASO	M609	
SAE	J2334	
Other	Immersion	Controlled/Adjustable RH
Options	Gas Injection	High/Low Temperature
	Multiple Electrolytes	
Custom		

This is a sample of global standards that can be met by this instrument. For more information on additional or specific standards, contact your local Atlas® representative. Standards are subject to change without notice. This might lead to the inclusion or exclusion of certain instruments.

Certain listed standards may require installed options.



Advanced Cyclic Corrosion Cabinet with Mechanical Cooling System



Features	SF	BCX	CCX w/Standard Controls	CCX w/Computer Controls
Durable Steel Cabinet, Exposure Zone lined with uniform PVC sheets	●	N/A	N/A	N/A
Insulated Exterior Panels with primer and top-coat, Interior Steel Shell primed on both sides	N/A	N/A	N/A	N/A
Reinforced Fiberglas™ Cabinet, Exposure Zone lined with gel coat	N/A	●	●	●
Solution Reservoir	208 l/55 gal	132 l/35 gal	227 l/60 gal	227 l/60 gal
Solution Mixing System	●	optional	optional	optional
Exposure Zone heated by Water Jacket	●	N/A	N/A	N/A
Exposure Zone heated by Air Jacket	N/A	N/A	N/A	N/A
Exposure Zone heated by Titanium Rod Heater	N/A	●	●	●
Clear Cover with Water Seal	●	N/A	N/A	N/A
Single Door with Plexiglas™ viewing window	N/A	N/A	N/A	N/A
Clear Cover with Dual Magnetic Santoprene™ gaskets	N/A	●	●	●
Opaque Polypropylene Cover with Water Seal	N/A	BCX9000	CCX9000	CCX9000
Peaked Cover/Ceiling prevents dripping onto samples	●	●	●	●
Heated Humidifying (Bubble) Tower with air relief valve	●	●	●	●
Exposure Zone Temperature with High Temperature Option	50° C/122° F 65° C/150° F	55° C/131° F 71° C/160° F	71° C/160° F N/A	71° C/160° F 90° C/194° F
Gas Injection	■	■	■	■
High Voltage Kit	■	■	■	■
High Capacity Oil: Water Separator	■	■	■	■
External Condensate Collection System	■	■	■	■
Exhaust Recirculation System	■	■	N/A	■
Air-actuated Cover, Automatic Ambient	■	■	■	■
Solution Spray (Direct Impingement)	N/A	■	■	■
Power Exhaust Kit	N/A	■	■	■
Water Fog, manual changeover	■	■	N/A	N/A
Water Fog, automatic	N/A	N/A	■	■
Controlled RH	N/A	N/A	■	■
Automatic Retractable Housing for RH Sensor	N/A	N/A	N/A	■
Immersion	N/A	N/A	N/A	■
LN2 Freezing/Cooling to -30° C / -22° F	N/A	N/A	N/A	■
Mechanical Refrig to -30° C and Controlled RH	N/A	N/A	N/A	■
Data recording PC software	■	■	■	■

● Standard ■ Optional



Technical Data:

Casing	Aluminum (specially anodized)
Interface	RS 232 C
Power Supply	Special Lithium high temperature battery
Max. Sensor Interior Temperature	80° C
Recommended Measuring Time	1 hour (minimum)
Max. Measuring Time	100 hours
Temperature Resolution	0.1° C
Measuring Range [°C]	20° C to 180° C
Operation Mode	Sensor is designed for non-turning mode operation
Calibration Interval	After 12 months or a measuring period of 500 hours

LS-200 Spectroradiometer



Calibration and Measurement Devices

Atlas® offers a variety of sensors for calibrating and measuring irradiance, radiant exposure and temperature at the sample level during an accelerated weathering test.

XenoCal® Irradiance Calibration Device

- For independent irradiance calibration and measurement at the sample plane
- Evaluation and graphical display of measured values using XenoSoft analytical software. Download it for free at www.atlas-mts.com
- Available with different wavelength sensitivities/combined with BST:
XenoCal BB 300 – 400/XenoCal BB 300-400 BST
XenoCal WB 300 – 800/XenoCal BB 300-800 BST
XenoCal NB 340
XenoCal NB 420
XenoCal LUX/XenoCal LUX BST

XenoCal UV Calibration Device for the Solar World

- XenoCal Solar sensor for monitoring the IEC UV preconditioning testing requirements inside UV test chambers
- XenoCal Solar measures irradiance (W/m²) or radiant exposure (kJ/m², kWh/m²). Depending on which IEC standard, values in two wavelength bands are displayed:
IEC 61215: IEC 61646:
280-320 nm 280-320 nm
280-385 nm 280-400 nm

XenoCal Temperature Calibration Device

- XenoCal BST and XenoCal WST
- For independent temperature calibration and measurement at the sample plane of Black Standard Temperature (BST) and measurement only of White Standard Temperature (WST)
- Evaluation and graphical display of measured values on a PC by means of the XenoSoft analytical software

LS-200

- Independent measurement of the spectral power distribution to verify conformance with performance-based standards
- Easy output of data in a spreadsheet format
- 300-800 nm measurement range

Technical Services

Proper maintenance and calibration are critical to maximize the reliability of your test data. A poorly maintained instrument can produce results that diminish the repeatability and reproducibility of the data. Instrument downtime delays your product's time to market. Atlas® is committed to helping you acquire the most accurate data possible with Technical Services.

Routine Maintenance*

We can help you at every step along the way, from installation to routine maintenance and calibration services. As part of Atlas' commitment to our customers, a factory-trained technician can inspect, start-up and demonstrate the capabilities of your new Atlas instrument.

At Start-up The Factory-trained Technician Will:

- Conduct a thorough inspection of the instrument, documentation and verify instrument configuration
- Verify software versions, installed test programs, ordered options
- Inspect installation and hook-up of electrical, water supply, drainage, and air supply to ensure efficient operation
- Explain and demonstrate operation of your new instrument
- Answer any questions concerning use of the equipment
- To make sure your instrument runs at optimum performance, your local technician will demonstrate calibration procedures
- Answer questions concerning calibration procedures and ordering consumables

Atlas recommends that we perform preventive maintenance and calibration for your instrument at least every six months. Some users find that they need more frequent maintenance and calibration due to high instrument utilization. Consult your owner's manual for information on scheduling maintenance or call your local technician with any maintenance and calibration questions.

Every Six Months:

- Inspect the operation of your instrument
- Perform detailed preventive maintenance including inspecting and adjusting temperature control circuits, meters, timing devices, lamp components, motors, switches, relays, water systems, and mechanical components that require periodic attention
- Replace any required parts
- Perform ISO 17025 accredited calibration of required circuits
- Submit a written report of current updates and changes that affect the operation of your instrument and maximize test performance



A2LA Accredited

Atlas calibration services are accredited by A2LA to meet ISO 17025 requirements. This includes xenon lamp and UVTest irradiance calibrations performed in our Chicago-based calibration laboratory using state-of-the-art irradiance measurement equipment, as well as on-site calibrations for both Atlas and competitors' weathering instruments by our experienced, factory-trained Technical Service staff. For more information about our scope of accredited calibrations, please contact info@atlas-mts.com.

*Services vary by location. Contact your local representative for availability and pricing.



Benchmark Exposure Sites

World's Largest Network of Natural Weathering Facilities

The climates of southern Florida and central Arizona are recognized as global benchmarks for natural weathering environments. The warm, humid, subtropical environment of our outdoor test sites in Miami and the intense sun and arid climate of our site in Phoenix are some of the harshest climates to which your products can be exposed. Often the best natural weathering test scenario requires testing in a variety of climates. For that reason, Atlas® offers the world's largest network of outdoor weathering test facilities with more than 23 sites worldwide.

Atlas Weathering Services Group - South Florida

South Florida Test Service (SFTS) continues to pioneer natural exposure testing. Located in a rural, unpolluted environment, SFTS provides clients with more than 70 years of experience in weathering. This site is used by companies worldwide for exposure testing of paints, coatings, textiles, plastics and other various products.



South Florida

Atlas Weathering Services Group - Central Arizona

Arizona, like Florida, possesses high levels of solar radiation and elevated temperatures. However, unlike Florida, Arizona has an arid climate that can have a distinct effect on material durability.

Atlas Weathering Services Group's Arizona desert site, DSET Laboratories, is in an unpolluted environment. Since 1948, DSET has offered desert exposure testing suitable for materials used in a wide range of industries, including automotive, construction and consumer products.



Central Arizona

Atlas Weathering Services Group - Sanary Sur Mer, France

The Bandol region of France possesses a typical Mediterranean climate. With 3,000 hours of sunlight per year, an elevation of 110 m (361 ft), average wet time of 2,700 hours, and a proximity to the Mediterranean Sea of only 4 km (2.5 miles), the site is used by many European companies to test a wide range of materials.

Atlas Weathering Services Group - Chennai, India

Located near Chennai, it is the first official outdoor exposure site in India and is characterized by a tropical climate with high levels of sunlight, humidity and temperature. This site provides valuable test data for many industries, including: automotive exterior and interior; architectural and building products; consumer durable goods; and lightfastness of textiles.

State-of-the-Art Weather Data Tracking and Reporting

Our benchmark exposure sites offer the latest technology in weather reporting instrumentation, such as total solar (UV, Visible and IR), total UV and narrow-band UV radiometers and pyrhelimeters. Instruments for monitoring ambient temperature and humidity, rainfall, total wet-time and wind speed are also employed. All instruments are directly traceable to national and international standards, including the World Radiometric Reference (WRR) and the National Institute of Standards and Technology (NIST).

Reporting

Reporting of testing results and test status are customized and delivered in electronic or printed formats. Electronic delivery of reports include:

- .pdf
- .xls

Quality Accreditation

Atlas' sites in Arizona, Florida and Sanary Sur Mer, France (ISO/IEC 17025 only) are accepted and accredited test laboratories by the following:

ISO/IEC 17025

Atlas® has always focused on being the quality leader in the weathering industry. As a result, Atlas was the first weathering organization to receive accreditation to ISO/IEC 17025, General Requirements for the Competence of Testing and Calibration Laboratories.

Atlas was also awarded the first ever A2LA ISO 17025 accreditation for technical competence in calibrating radiometers used for solar and various light source irradiance measurements.

AMECA

Atlas laboratory facilities and personnel are fully accredited by the Automotive Manufacturers Equipment Compliance Agency, Inc. (AMECA), for compliance with all AMECA laboratory requirements.

AAMA

Atlas is an approved laboratory to perform American Architectural Manufacturers Association (AAMA) indoor and outdoor test methods.

CRRC

The Cool Roof Rating Council (CRRC) has accredited Atlas Weathering Services Group as the first approved Test Farm facility for the CRRC's Product Rating Program. To earn the coveted CRRC rating, roofing manufacturers and sellers must perform weathering tests through Atlas for three years at locations in Florida (hot/humid), Arizona (hot/dry) and the Midwest (cold/temperate).

For more detailed information about accreditation at any of our outdoor sites, contact your local Atlas representative.

Test Site Data

	Florida SFTS	Arizona DSET	Sanary, France
Latitude	25° 52' N	33° 54' N	43° 08' N
Longitude	80° 27' W	112° 8' W	5° 49' E
Elevation	3 m	610 m	110 m
Avg. High Temperature			
Summer	34° C (93° F)	39° C (102° F)	23° C (73° F)
Winter	26° C (79° F)	20° C (68° F)	9° C (48° F)
Avg. Relative Humidity			
	78%	37%	76%
Total Rain	1685 mm	255 mm	700 mm
Total UV 295-385 nm			
	280 MJ/m ²	333.5 MJ/m ²	382.4 MJ/m ² *
Total Radiant Energy 295-3000 nm			
	6588 MJ/m ²	8004 MJ/m ²	5500 MJ/m ²

* Data measured from 300-400 nm

Average Monthly UV and Total Radiant Energy (MJ/m²)

Month	26° South (Miami)		34° South (Phoenix)	
	UV	Total	UV	Total
January	20.0	505	20.1	490
February	22.5	545	19.8	546
March	26.5	618	24.7	633
April	28.0	612	33.3	755
May	28.0	609	38.6	786
June	25.7	543	36.8	770
July	24.7	532	35.1	745
August	24.0	543	32.5	756
September	22.3	540	29.3	711
October	21.7	555	25.8	705
November	18.0	490	19.2	582
December	18.6	496	18.3	525
Annually	280.0	6588	333.5	8004



Atlas® Worldwide Exposure Network

Atlas offers outdoor weathering sites worldwide to ensure factors from a variety of climates are considered.

For example, the Atlas site in Sanary Sur Mer, France, is the benchmark for the European climate, our site in Hoek van Holland (North Sea Corrosion Test Center) represents the corrosive marine environment of western Europe, and the Atlas site in Jacksonville, Florida, provides representative exposures to acid rain and other environmental pollutants.



Annual Climatological Data*

	Latitude	Longitude	Elevation (m)	Avg. Ambient Temp. (°C)	Avg. Ambient RH (%)	Rainfall (mm)	Energy (MJ/m ²)	Total Radiant
Prescott, Arizona	34° 39' N	112° 26' W	1531	12	65	1093	7000	
Phoenix, Arizona	33° 54' N	112° 08' W	610	22	37	255	8004	
Chicago, Illinois	41° 47' N	87° 45' W	190	10	69	856	5100	
Medina, Ohio	41° 07' N	81° 54' W	336	10	72	844	5100	
Keys, Florida	24° 33' N	81° 45' W	1	25	73	989	N/A	
Jacksonville, Florida	30° 29' N	81° 42' W	8	20	76	1303	5800	
Miami, Florida	25° 52' N	80° 27' W	3	23	78	1685	6588	
Alberta, Michigan	46° 65' N	88° 48' W	399	6.1	64	847	N/A	
Ottawa, Canada	45° 20' N	75° 41' W	103	6	73	1910	4050	
Hoek van Holland, The Netherlands	51° 57' N	04° 10' E	6	10	87	800	3800	
Sanary, France (Bandol)	43° 08' N	05° 49' E	110	13	64	1200	5500	
Novorossiysk, Russia	44° 43' N	37° 46' E	30	12	77	1390	4980	
Singapore (Changi Airport)	01° 22' N	103° 59' E	15	27	84	2300	6030	
Hainan, China	19° 15' N	110° 28' E	10	24	81	2013	4664	
Guangzhou, China	23° 08' N	113° 17' E	6	22	79	1492	4590	
Chennai, India	12° 35' N	79° 48' E	45	28	72	1252	6760	
Seosan, Korea	36° 55' N	126° 21' W	6.5	11.8	75.4	1235	4700	
Miyakojima, Okinawa	24° 44' N	125° 19' E	50	23	76	1741	4894	
Choshi, Japan	35° 43' N	140° 45' E	53	14	78	1682	4659	
Melbourne, Australia	37° 49' S	144° 58' E	35	16	62	650	5385	
Townsville, Australia	19° 15' S	146° 46' E	15	25	70	937	7236	

* Extracted from published data or measured at test site.

† Other sites in Australia are also available, please contact your local Atlas representative for more information.



Laboratory Accelerated Weathering Services

World's Largest Network of Independent Weathering Testing Laboratories

Atlas® Weathering Services Group (AWSG) operates one of the largest networks of ISO/IEC 17025 accredited accelerated weathering testing laboratories in the world. With laboratories in the USA, Germany, France and the United Kingdom, AWSG's indoor exposure laboratories offer artificial accelerated weathering tests and a variety of other environmental test programs, all designed to accurately simulate true end-use conditions and meet global weathering standards.

Standards

Our network of laboratory accelerated weathering testing and evaluation services is ready to test your products to a variety of global testing standards, including:

AATCC	16	177			
ASTM	B117	D2565	D2803	D4355	D4674
	D5894	D6695	E1596	G151-155	
BMW	PrV306				
DIN	75 220				
Federal	Test Method 191 (Methods 5660, 5671, 5804)				
Ford	BI 103-01	FLTM B0	116-01		
GM	3414TM	4298P	9505P	9540P	14162
	14872	60292			
IEC	68-2-5				
ISO	105-A01	105-B02	105-B04	105-B06	2813
	4628	4892	7668	7724-2	7724-3
	9022-9	9227	11341	11507	12040
Marks & Spencer	C9	C9A			
Military	Mil Std 810 G (Method 505.5)				
Nissan	NES M0 135				
RAL-GZ	716/1				
Renault	D27 1911/C		D47 1122/D		D47 1431
SAE	J1885	J1960	J2020	J2334	
	J2412	J2527			
VDA	75202				
VW	PV 1211	PV 1303	PV 1306	PV 1323	
	PV 3929	PV 3930			

To find out more details about test programs to meet these or other specific standards, contact your local Atlas representative. Standards are subject to change without notice. This might lead to the inclusion or exclusion of certain instruments.



Complete Testing Facilities

Our network of laboratories provides a comprehensive array of Atlas accelerated laboratory weathering and evaluation equipment, including:

- Ci3000+ Fade-Ometer®
- Ci3000+, Ci4000 and Ci5000 Weather-Ometers
- Ci35A and Ci65A Weather-Ometers
- CDMCA Enclosed Carbon Arc Weather-Ometer®
- CXWA Sunshine Carbon Arc Weather-Ometer
- HPUV™ Indoor Actinic Exposure System
- SolarClimatic Solar Simulation Chamber
- SUNTEST® XLS+ and CPS+
- SUNTEST XXL+
- UVTest™ UV Condensation Weathering Device
- VIEEW® Digital Image Analyzer
- Xenotest® 150 S+, Alpha+, Beta+ and 1200 LM
- SF850 and CCX2000 Corrosion Cabinets



Static Exposure Testing

Direct Weathering

Atlas® outdoor exposure laboratories offer a variety of direct weathering options to meet international and manufacturer-specific test programs and to simulate end-use conditions.

Open-Backed Exposures

- Allows for majority of specimen material to be exposed to circulation of ambient air
- Racks specifically angled to best replicate end-use conditions
- Exposures for a variety of sizes from small, coupon-sized samples, to window assemblies and automotive components, to entire vehicles

Backed Exposures

- Specimens are mounted to substrate, typically 12 mm (½") exterior-grade plywood, to simulate end-use environment by insulating back sides of specimens and increasing sample temperature
- Racks specifically angled to best replicate end-use conditions

Black Box Exposures

- Simulates air heat-sink characteristics of automobile bodies and increases sample temperature
- Black painted, metal box
- Panels on exposure cover the open top of the box and reach temperatures comparable to those of hoods, roofs and deck lids of automobiles parked in direct sunlight



Open-Backed
Exposures



Backed Exposures

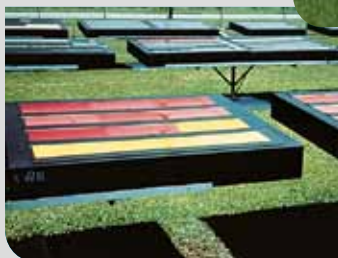

Black Box
Exposures

Standards

	Fixed or Variable Angle/ Open-Backed or Backed	Black Box
AATCC	111 A	
ASTM	D1006 D1014 D1435 D3679 D4726 E1596 G7	D4141 A G7
ECCA	T19	
Ford	FLTM BI 160-01	
GM	3619M 9163P 9327P 9758P GMW14873	9163P GMW14873
ISO	105-B03 877-1 877-2 2810 4665 8565	
SAE	J576 J1976	J1976

To find out more details about test programs to meet these or other specific standards, contact your local Atlas representative. Standards are subject to change without notice. This might lead to the inclusion or exclusion of certain services.

Scab Tests

Scab tests on coated metal automotive panels are commonly performed to evaluate the cosmetic corrosion that might occur in coated metal panels that have been damaged and exposed to highly salted environments, such as road salt or coastal areas. This test is performed in accordance with ASTM D6675 – “Standard Practice for Salt-Accelerated Outdoor Cosmetic Corrosion Testing of Organic Coatings on Automotive Sheet Steel.” This practice defines the procedure for preparing, exposing and applying a 5% sodium chloride solution at specified intervals to promote corrosion.

Indirect Weathering

Atlas® outdoor exposure laboratories offer a variety of indirect weathering options to meet international and manufacturer-specific test programs for materials that are typically not exposed to all outdoor conditions.



Under Glass and Black Box Under Glass Exposures

- Provides exposure to natural sunlight through glass
- Determines colorfastness/durability characteristics of materials such as: drapes, carpeting, upholstery and automotive interior materials
- Specimens are typically placed behind 3 mm thick, single-strength window glass
- Single-strength window glass absorbs radiation below 310 nm and transmits 77% of UV radiation and 85% of visible light
- Additional tempered, tinted or laminated glass available to match end-use application

Standards

	Under Glass	Black Box Under Glass
AATCC	Method 16 Option 6, TM111B	
ASTM	G24 Method A	G24 Method B
FLTM	BI 160-01	BI 160-01
GM	4349M	
ISO	105-B01	877-2

To find out more details about test programs to meet these or other specific standards, contact your local Atlas representative. Standards are subject to change without notice. This might lead to the inclusion or exclusion of certain services.

Common Applications

Open-Backed Exposure, Black Box Exposure, Under Glass and Black Box Under Glass

Paints and Coatings



Plastic Lenses
(such as taillight assemblies and automotive coatings)



Plastic and Metal Signs

Other Applications:

Glass
Free-Films
Coil Coatings

Backed Exposure

Automotive Moldings



Polyvinyl Chloride (PVC) Siding



Roofing Membranes





Schematic of EMMAQUA

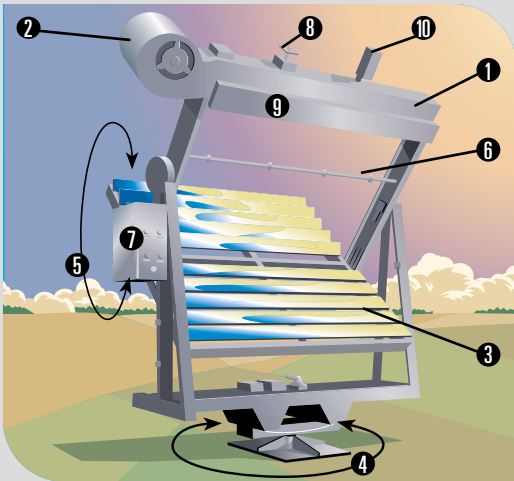

- | | |
|----------------------------------|-------------------------------|
| 1. Air Tunnel | 7. Microprocessor Control Box |
| 2. Air Blower | 8. Solar Cells/Shadow Hat |
| 3. Mirror | 9. Specimen Protection Door |
| 4. Rotation, Azimuth Direction | 10. Door Release Mechanism |
| 5. Rotation, Elevation Direction | |
| 6. Water Spray Nozzles | |

EMMAQUA® (Equatorial Mount with Mirrors for Acceleration, with Water [AQUA])

Weathering with Sunlight in a Fraction of the Time

EMMAQUA employs 10 highly-reflective mirrors and a sun-tracking system to concentrate sunlight onto test specimens. The result is natural weathering testing in a fraction of the time. In addition, you get the closest correlation to end-use conditions because samples are exposed to the full spectrum of natural sunlight.

Test Apparatus

DSET Laboratories pioneered the development of the EMMAQUA outdoor accelerated test methods in the early sixties. The method employs Fresnel reflecting solar concentrators that use ten flat mirrors to uniformly focus natural sunlight onto specimens mounted in the target plane. High quality, first-surface mirrors provide an intensity of approximately eight “total suns” with the spectral balance of natural sunlight in terms of ultraviolet integrity.

The target board, located at the focal line of the mirrors, lies along a wind tunnel along which a deflector directs cooling air across the specimens. A nozzle assembly sprays the specimens with deionized water in accordance with established schedules to simulate subtropical, semi-humid and temperate regions.

Night time spray cycles can be used to keep samples moist during the non-tracking portion of the test to provide the total time of wetness typically encountered in subtropical regions.

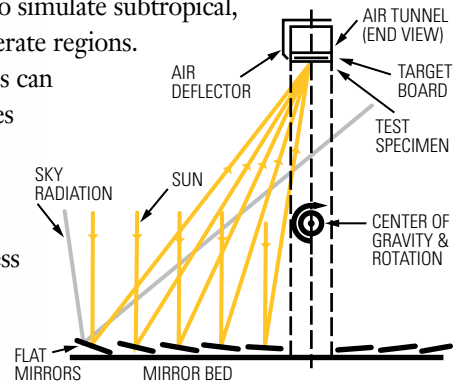

Features

- Microprocessor Control
- Programmable Cycles
- Dual Axis Tracking
- Thermal Shocks
- Night Time Dew
- Patented Temperature Control

Average Annual Ultraviolet Radiant Exposure

Atlas® recommends the exposure of test specimens on an EMMAQUA® based on accumulated doses of ultraviolet radiation measured in MJ/m². The duration can be based on Arizona or Florida equivalents. The UV radiation must be measured as direct beam to avoid errors in evaluating the exposure duration.

FLORIDA				
Location	5°	26°	45°	90°
Radiant Energy MJ/m² UV	310	280	290	180

ARIZONA				
Location	5°	34°	45°	90°
Radiant Energy MJ/m² UV	360	333.5	330	200

Sample Specifications

Target board size: 13 cm x 143 cm (5" x 55")

Recommended sample sizes: 5 cm x 13 cm (2" x 5")
7.5 cm x 13 cm (3" x 5")

Maximum thickness: 13 mm (0.5")

Standards Specifying the EMMAQUA Method

EMMAQUA meets or exceeds the following industry standards:

AAMA	624+	625+	
ASTM	D4141▼	D4364■●▲▼	D5105▼
	D5722+	E1596▼	G90■●▲▼
SAE	J576■	J1961■▼	
Ford	ESB-M16J14-A▼	WSS-M28P1-B1▲	
ISO	877-3 ■●▲▼		
ANSI/NSF	54▲		
JIS	Z 2381■▲▼		
MIL	T-22085D■▲		

- EMMA®
- EMMA – UG (Under Glass)
- ▲ EMMAQUA / EMMAQUA+ (Cycle 1 of ASTM G90)
- ▼ EMMAQUA – NTW (Night Time Wetting, i.e., Cycle 3)
- ✦ EMMAQUA – Soak/Freeze/Thaw Cycle
- ✦ EMMAQUA – NTW (Night Time Wetting, 70° C +/- 5° C)

To find out more details about test programs to meet these or other specific standards, contact your local Atlas representative. Standards are subject to change without notice. This might lead to the inclusion or exclusion of certain services.

Common Applications

Adhesives



Automotive Exteriors

Packaging



Paints and Coatings

Plastics



Roofing

Other Applications:

Agricultural Films
Building Materials
Elastomers

Glass (Arch. & Auto)
Sealants



Temperature and Moisture Controlled EMMAQUA®

Our Patented Temperature Control System Ushers in a New Era for Accelerated Outdoor Testing

Accelerated outdoor testing has often been thought of as the ultimate in solar weathering testing. Your samples are subject to actual fluctuations that products see in their end-use environment and harnessing actual sunlight, rather than a simulated light source. This gives researchers the best correlation to solar degradation. The drawback to traditional accelerated outdoor testing has been the extreme temperatures and irregular water uptake levels that are a natural side effect of solar multiplication in an EMMA® or EMMAQUA device.

Atlas® now offers a solution to control temperature in accelerated outdoor testing. Our patented temperature and moisture control systems allow customers to manage thermal buildup during an accelerated outdoor test. These patented systems can be used independently or in various combinations to create the most accurate accelerated outdoor testing results available in the industry today.

- Helps overcome effects of starting tests at different times of year (winter vs. summer)
- Greatly reduces temperature intermittency effects
- Manages maximum temperatures throughout the test to a user defined set-point
- Increases exposure temperature if desired
- Increases morning and afternoon exposure temperatures

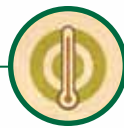

Static Control

A temperature sensor mounted in the exposure target area interfaces with a controller that powers the variable-speed blower motor that maintains specimen temperature to a user-defined set point.

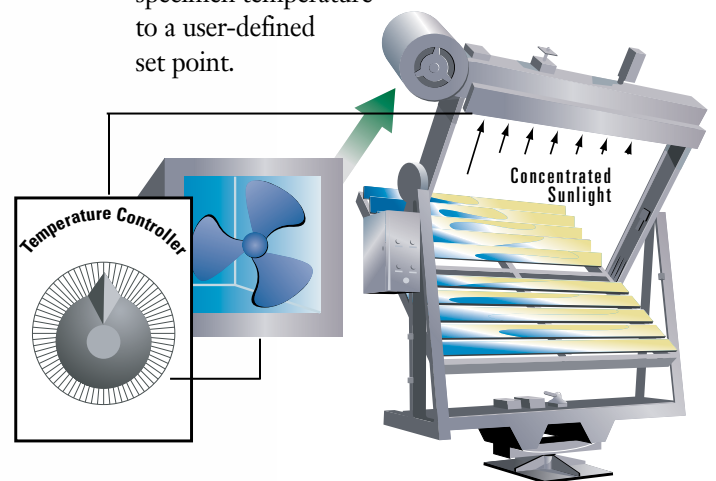

Dynamic Control

Two temperature sensors are used, one in the exposure target area and a remotely located temperature sensor. The controller compares the two sensors and adjusts the cooling blower speed to match the remote sensor temperature.

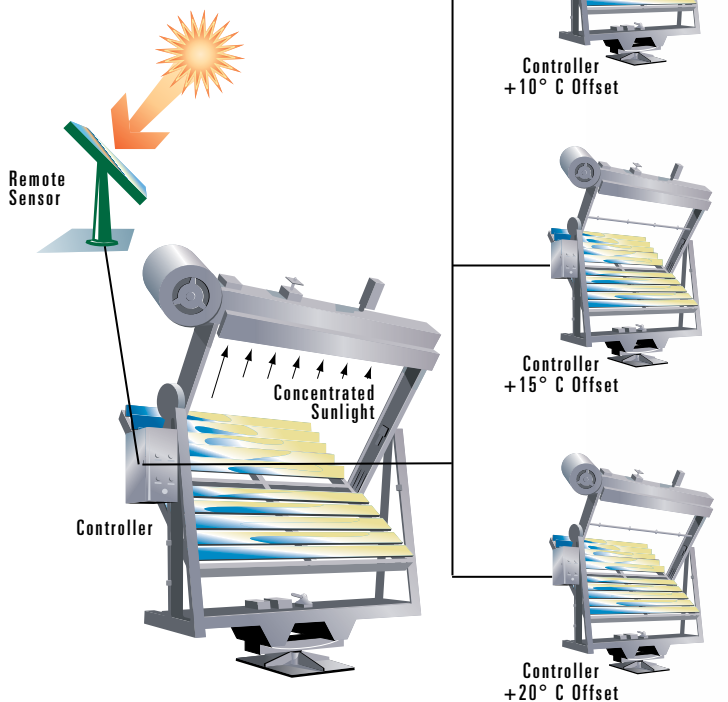

- Approximates intermittent temperature patterns found in natural exposures on an accelerated test
- The remote sensor may be black panels, end-use materials on exposure racks and even full-scale installations
- Target area temperature sensors can be mounted as standard black panels or even some customer specified materials
- The system can incorporate a variety of temperature offsets while maintaining natural environmental temperature patterns

Night Temperature Control

Special heater platens are mounted behind specimens on the target area to offset cooler seasonal nighttime temperatures. Specimens receive radiative, convective and conductive heating through the unexposed side.

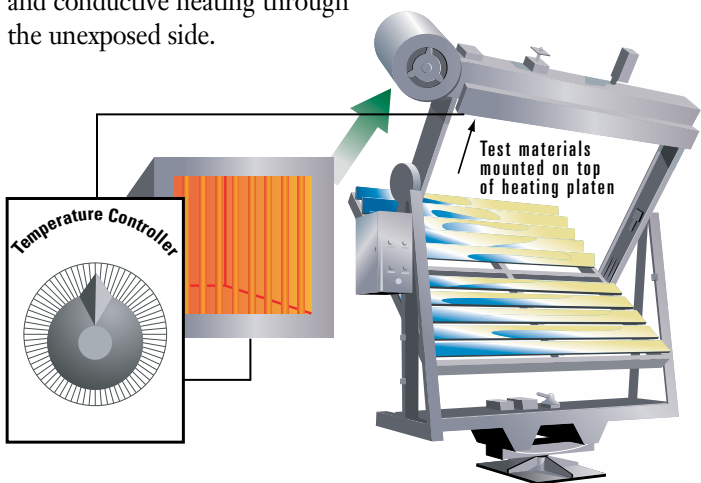

- Can approximate summer nighttime temperatures during winter exposures
- Helps overcome effects of starting tests at different times of year (winter vs. summer)
- Enhances nighttime wetting degradation for some materials
- Improves acceleration factors by speeding thermal degradation for some materials
- Improves dark time reaction degradation for some materials

Temperature and Moisture Controlled
EMMAQUA® continued

- Allows temperature sensitive materials to utilize EMMA exposures at different levels of acceleration
- Allows investigation of effects from different solar and UV irradiance levels
- Allows investigation of a material's reciprocity characteristics
- Maintains natural intermittent patterns of light and temperature while varying light and temperature levels
- Can be used to design sophisticated and controlled weathering experiments
- May allow better correlation between accelerated and end-use weathering exposures
- Reduces material exposure temperature below other Atlas® Temperature Controlled EMMA products

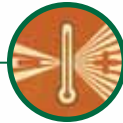

Variable Irradiance Control

The number of mirrors in the EMMA® device is varied between two and ten depending on the exposure requirements of the material. A temperature control system is typically used in conjunction with this system for finer control.



2 Mirrors	4 Mirrors	6 Mirrors	8 Mirrors	10 Mirrors
1/5 Standard Irradiance	2/5 Standard Irradiance	3/5 Standard Irradiance	4/5 Standard Irradiance	5/5 Standard Irradiance
5x Standard Irradiant Exposure	2.5x Standard Irradiant Exposure	1.67x Standard Irradiant Exposure	1.25x Standard Irradiant Exposure	1x Standard Irradiant Exposure

- Customization of spray cycles at varying frequency and duration to meet specific material needs
- Ability to overcome “lensing” and thermal shock effects of wetting specimens in concentrated sunlight
- Fine tuning of ratios of light dose to wet time to more closely simulate end-use conditions and/or accelerated degradation rates
- Design of custom wetting cycles to accommodate different water absorption rates for different materials



Moisture Control

The target area rotates out of the concentrated sunlight prior to spraying the specimens. Blown-air cools test specimens to ambient temperatures. Specimens are sprayed with ultra-pure water for the customized length of time. The programmable logic controller then rotates the test samples back into focus at the end of the water spray cycle.

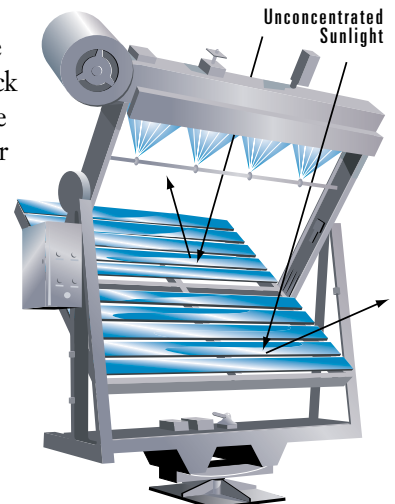

Automotive Exposure Testing

Comprehensive Vehicle Testing, from Samples to Components, to Complete Vehicles

IP/DP (Instrument Panel/Door Panel) Box®

- Under glass weathering method to determine durability and/or colorfastness of materials used for automotive interiors
- Cabinet is designed to accommodate nonstandard specimen sizes such as complete automotive assemblies, as well as standard 10 x 15 cm (4" x 6") samples
- 51° angle, azimuth tracking, sealed, temperature-limiting boxes
- 45° angle, south facing, non-tracking, sealed, temperature-limiting boxes are also available
- Can be customized with client-provided windshield or side window glass to evaluate effects of different types of glass on automotive interior components
- Humidity provided via optional water tray

Standards

Exposure testing is conducted to meet or exceed the following industry standards:

GM 2617M 7455M 9538P GMW3417

To find out more details about test programs to meet these or other specific standards, contact your local Atlas® representative. Standards are subject to change without notice. This might lead to the inclusion or exclusion of certain services.

Atlas Weather Station

The Atlas Weather Station is ideal for customers who want to have their own test sites or who want to map various global climates.

Three different options are available:

Option A

- Includes the Weather Station support mount, a UV and global radiometer, data collection capabilities and remote solar power

Option B

- Includes Option A with the addition of temperature and humidity probe

Option C

- Custom per customer requirements
- Solar Weather Station option

Natural & Accelerated
Weathering Services



IP/DP Box
Atlas Weather Station



SAE J576 – Static Exposure

AWSG offers a packaged program for those needing the requirements of SAE J576 and Federal Motor Vehicle Safety Standard 571.108 for plastic lens material. The SAE J576 program provides a single source of both Arizona and Florida exposure tests and all optical property measurements. We recommend evaluations at one and two years for both sites to determine if problems exist with their materials prior to the end of the three year test.

- Automotive plastic lens materials undergo three years static weathering in Florida and Arizona, along with special inspection and optical property measurements



- Evaluations include haze, luminous transmittance, chromaticity coordinates and visual inspection for cracking, crazing, delamination and color bleeding



- For screening purposes, plastic lens material can be exposed in an EMMAQUA® with nighttime wetting to quickly determine possible failures of specimens
- A mandatory 2-hour heat test at $79 \pm 3^\circ \text{C}$ will be conducted in a circulating air oven according to SAE J576c

For more information regarding requirements for meeting and testing to SAE J576, please contact your local service representative.

Complete Vehicle Testing

In addition to providing full service testing of individual automotive interior/exterior components, Atlas® also provides facilities for evaluating complete vehicles.

- Florida and Arizona facilities evaluate material durability of complete vehicles and compatibility of vehicle components
- Provides test conditions that match exact end-use conditions and full confidence of material's weathering performance
- Shielded exposure compounds available for test confidentiality
- Typical vehicle exposure programs include the following services:
 - Exposure of vehicle(s) in Florida and/or Arizona
 - Monthly visual inspection
 - Monthly washes and vacuuming
 - Temperature studies
 - Comprehensive reports (including photos)

Special Measurements

- Peak or continuous component temperature measurements
- UV light deposition on interior or exterior materials
- Thermal comfort analysis of new design automotive windows
- Dimensional stability of plastic body parts

Sun Tracking Carousel

- Only Atlas offers complete vehicle sun tracking carousel devices
- Carousels utilize a follow-the-sun tracking system that maintains direct exposure on specific locations of test vehicles throughout the day
- Provides data for peak component temperatures in the shortest possible time



Sun Tracking Carousel





Ultra-Accelerated Weathering System

Ultra-Accelerated Weathering System

Similar in concept to Atlas' moderately accelerated EMMA® technology, this ultra accelerated device tracks the sun while concentrating reflected sunlight on test specimens mounted in a target area. The difference, however, is the new patented mirror system utilized in the ultra-accelerated concentrator. Having very high reflectance in the UV and near visible wavelength ranges while attenuating reflectance in the longer wavelengths visible and IR portions of the solar spectrum, this technology allows for:

- Very high concentrations of UV energy without excessive heating of test samples
- A direct normal 100/1 concentration factor able to deliver approximately 63 years of South Florida UV radiant exposure in a single year
- Customized exposure projects to meet specific material requirements
- Consistency with the sun's UV spectrum
- Appropriate material exposure temperatures

Atlas® Outdoor Exposure Rack System

The Atlas Outdoor Exposure Rack design takes into account the best features of the historical exposure racks used at weathering sites around the world and incorporates ideas from our in-house weathering technicians and experts. We asked the question, "How can we make the exposure rack better?" and we are sure the new Atlas Exposure Rack has answered that question with improved ease of use and more!

How is the Atlas Exposure Rack an improvement over the historically available exposure rack and other exact clones in the marketplace?

1. Atlas has improved on the old flap-assembly's traditional wingnut fasteners with an ergonomically friendly cam-lock design.
2. Atlas has also designed new "quick-release" hardware to panel and sample mounting hardware such as the flap assembly that will allow in-place removal as opposed to the slide functionality of traditional model racks.

These enhanced test racks continue to meet all applicable outdoor weathering standards, but now with better construction and ease of use.

Atlas also manufactures portable all-terrain racks, offset racks and other specialty exposure racks.



Flap Assembly with "Quick-release" Hardware



Evaluation Services

Analytical Services to Complete Any Testing Program

Atlas® offers a wide range of evaluation and measurement services for your specimens during and after the weathering process. Evaluation services are available at many Atlas global weathering facilities. To find Atlas evaluation services for your company's needs, contact your local Atlas representative.

Photography/IR Imaging Services

Photography and Infrared Imaging are available to complement our evaluation services. Images of specimen degradation and heat loss can be taken digitally and provided via e-mail or CD-ROM.



Visual Evaluation

A variety of visual assessment services are available for rating degradation phenomena on specimens associated with the weathering process. Evaluation services are conducted to meet the global standards listed below.

Instrumental Optical Properties

The measurement of color and evaluation of other optical properties are often chosen as the principal technique for quantifying material degradation resulting from natural and accelerated exposure tests.

Evaluation Services Standards

Coating Adhesion	ASTM D3359	GM 9071P
Blistering	ASTM D714	ISO 4628-2
Chalking	ASTM D4214	ISO 4628-6
Checking	ASTM D660	ISO 4628-5
Cracking	ASTM D661	ISO 4628-4
Erosion	ASTM D662	
Mildew	ASTM D3274	
Grey Scale Evaluation	AATCC Evaluation Procedure 1	
	ASTM D2616	
	DIN EN 20105-A02	
	ISO 105 A02	

To find out more details about test programs to meet these or other specific standards, contact your local Atlas representative. Standards are subject to change without notice. This might lead to the inclusion or exclusion of certain services.



Common Applications

Evaluation services are used by a variety of industries for a variety of applications, including:

Automotive Interior,
Exterior Materials
and Components



Building Products

Other applications:

Construction Materials
Paints and Coatings
Plastics



Color Measurement
Chalking Evaluation



Color Measurement

Spectrophotometric color measurements are provided on three types of instrumentation. Atlas® has instrumentation for measuring both transmittance and reflectance, specular included and excluded, in a sphere geometry. Our instruments measure reflectance in a 0°/45° geometry. Atlas has portable instruments for field evaluations that measure reflectance, specular included only. Color scales include CIE L*a*b*, HunterLab, CIE XYZ, CMC and Yellowness and Whiteness indices. Illuminants include D65, C, A and F among others; 2° and 10° observer are available.

Gloss Measurements

Atlas uses bench-top and portable BYK Gardner glossmeters for both laboratory and field measurements at 20°, 60°, 75° and 85°.



Distinctness-of-Reflected Image (DOI)

DOI is the sharpness with which object outlines are reflected by a surface. This measurement is predominantly used by automotive and architectural coatings manufacturers to characterize a desired appearance for the end product. Atlas laboratories use the latest technology and equipment to make DOI measurements, including wide and narrow angle haze measurements.

Spectrophotometry

Absolute or relative spectral measurements as a function of incident angle are available through Atlas laboratory services. Instrumentation includes a Perkin-Elmer Lambda 950, spectrophotometer equipped with specially designed integrating spheres. Data for UV-VIS-NIR measurements include report and one normalization (e.g., solar transmittance or reflectance, color, chromaticity, etc.), in accordance with ASTM E903.

Transmission Haze and Clarity

Atlas uses a BYK Gardner Haze-Gard Plus to measure haze, total transmittance and clarity. The instrument measures total and diffuse transmittance to a 2° observer to illuminant C.

Non-destructive Dry Film Thickness

Atlas uses BYK Gardner Micro-Tri-Gloss instruments with film thickness capabilities, in accordance with ASTM D7091.

Emittance

Emittance measurements are performed using a Gier-Dunkle DB-100 IR reflectometer, emissometer which measures wavelength range of 2.5-40 microns, in accordance with ASTM E408.

Solar Reflectance Index

SRI is a value that incorporates both Solar Reflectance measurements (ASTM E903), and Emittance measurements (ASTM E408), into a single value that represents the temperature of a material in the sun. The value represents how hot a surface would get in comparison to a standard black surface (SRI=0), and a standard white surface (SRI=100). SRI is calculated in accordance with ASTM E1980 – Standard Practice for Calculating Solar Reflectance Index of Horizontal and Low Sloped Opaque Surfaces.

Window Energy Analysis

Shading Coefficient and U-Value Analysis

Determining the Shading Coefficient (SC) for a window system provides important marketing and technical data for that system. The SC, along with the U-Value of a particular fenestration, permits the designer to perform heat gain and heat loss calculations, important in today's competitive marketplace.

A Shading Coefficient is the ratio of solar heat gain through a glazing system to the solar heat gain through a single lite of double-strength sheet glass, when both are tested under a specific set of conditions. The U-Value is the total heat transfer coefficient in a window system.

- SC and winter and summer U-Values are calculated using methods based on the ASHRAE Handbook of Fundamentals
- Calculations can only be performed on smooth surface window systems
- Measurements required are thermal emittance, transmittance and reflectance of each window surface

Window Energy Analysis Standards

Window Energy Analysis is conducted to meet or exceed the following industry standards:

NFRC	300-93	301-93
ASTM	E903	

To find out more details about test programs to meet these or other specific standards, contact your local Atlas® representative. Standards are subject to change without notice. This might lead to the inclusion or exclusion of certain services.



Emittance

Measurement Evaluation Standards:

Instrumental Optical Properties evaluations are conducted to meet or exceed the following industry standards:

Color			
ASTM	D2244	E308	E313
	E1331	E1348	E1349
DIN	6174		
ISO	7724		
SAE	J1545		
Gloss			
ASTM	D523		
DIN	67530		
ISO	2813		
DOI			
ASTM	E430		
Spectrophotometry			
ASTM	E 308	E 903	
Emittance			
ASTM	E 408		
Transmission Haze and Clarity			
ASTM	D1003		

To find out more details about test programs to meet these or other specific standards, contact your local Atlas representative. Standards are subject to change without notice. This might lead to the inclusion or exclusion of certain instruments.



Additional Services

Temperature Recording

Temperature data on all types of materials in most configurations can be provided. Temperature monitoring programs can be provided for single and multiple specimens under any type of exposure, as well as for large assemblies such as complete vehicles.

Service Types are Defined as:

- Non-recording (Manual) — measurements taken with a hand-held digital thermometer at specified points during the day
- Continuously recording (Automatic) — measurements taken with a programmed data acquisition system

Radiometer Measurement and Calibration

Atlas® offers solar radiometer outdoor calibration service directly traceable to the World Radiometric Reference (WRR) or National Institute of Standards and Technology (NIST). These radiometers include pyranometers and pyrhemometers, which measure total sunlight and total or narrow-band ultraviolet radiometers. Atlas was awarded the first A2LA ISO 17025 accreditation for technical competence in calibrating radiometers.



Pyrhemometers



Black and
White Panels

Temperature measurements performed per ASTM G179.



Radiometer Rack

Various instruments are used to monitor solar radiation, temperature and other parameters of weathering.



45° Pyranometer

Calibrations Include:

- Transfer of calibration from reference to field radiometers
- Transfer of calibration from reference pyrhemometers to field pyrhemometers

Standards

Radiometer Measurement & Calibration are performed to meet or exceed the following industry standards:

ASTM	E816	E824	G130
ISO/IEC	9059	9847	

To find out more details about test programs to meet these or other specific standards, contact your local Atlas representative. Standards are subject to change without notice. This might lead to the inclusion or exclusion of certain services.

Mounting Techniques

Specimen Preparation and Mounting

The following information provides general guidelines for the types and sizes of specimen preparation and mounting required for most of our outdoor services. Customized preparation and mounting is available for some services; talk to an Atlas® representative about your specific testing needs.

Panels and Samples

A panel is defined as any flat specimen up to 305 mm (12") along one edge and must be sufficiently rigid to be self-supporting and can be mounted without special handling in a standard panel rack equipped with a mask. All AWSG panel racks are equipped with masks preset to either 152 mm (6"), 228 mm (9") or 305 mm (12"). Panel fees apply for panels up to 152 x 305 mm (6" x 12").

All specimens outside the panel definition shall be considered samples, and fees apply to samples up to 305 x 305 mm (12" x 12"). For larger specimens, multiples of the stated sizes or any portion thereof, will be used to determine fees.

EMMA®/EMMAQUA®

Open-Backed Exposure
can also be used in static weathering

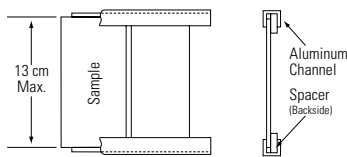

Backed Exposure

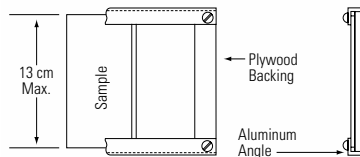

Pictorial Definition of Panel

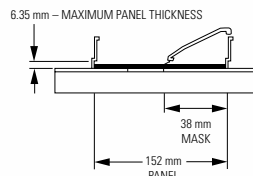
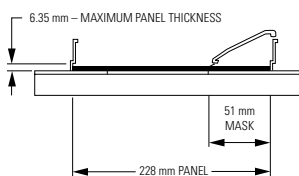
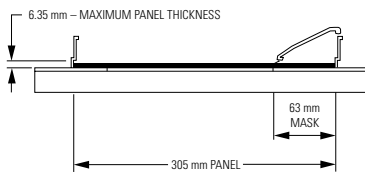

Special Glass Mounting Technique Open-Backed Exposure

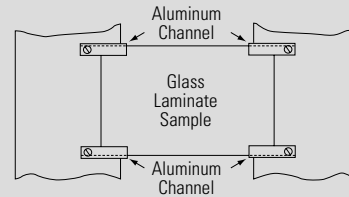

Open-Backed Exposure Exposed Edge

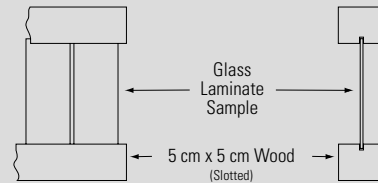

SAE J576 Disc

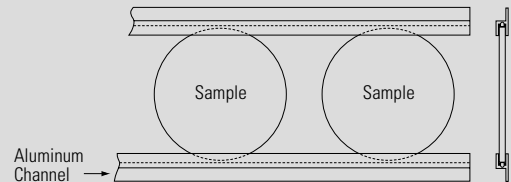

Open-Backed and Backed Exposure Rack Harrison Style Rack

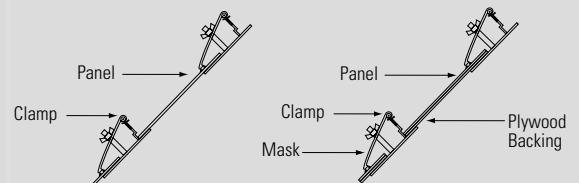

Alternate Style Rack

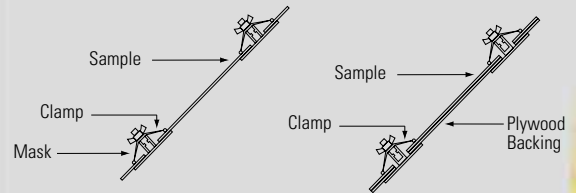

Solid Plywood or Screen Mesh Backed Exposure

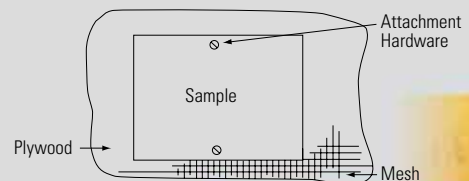



Our Services Include:

Weathering Technology Consulting

- Process Assessment
- Process Management
- Service Life Solutions
- Test Facility Design

Education and Training

- Seminars
- Workshops
- In-House Programs
- Technical Conferences

Test Methods and Experiments

- Test Method Review and Design
- Test Method Implementation
- Weathering Experiments
- Numerical Simulation

Consulting Solutions

Atlas Consulting Solutions offers design and implementation of complete testing and durability solutions. We help customers achieve objectives through all stages of the value chain from materials to components, systems to end-use products.

Atlas consulting helps you:

- Meet durability and testing goals
- Back up warranty statements
- Avoid premature failures
- Save time and money
- Strengthen market position
- Manage changes
- Achieve the best possible correlation, precision and acceleration of your tests

Solar Simulation Systems

Whatever the climate or condition, Atlas® designs solar chambers for environmental testing of photovoltaic and solar thermal related products.

From our small and medium chambers to our Custom Simulation Systems*, Atlas Solar Simulation Systems are designed to:

- Elicit environmental durability effects
- Define light-induced defects
- Measure performance characteristics



SolarCellTest 575

SolarTest 1200



*Refer to pages 33-34 for Custom Designed Solar Simulation Systems.



Solar Test Center

The Atlas® Solar Test Center is an ISO 17025, Underwriters Laboratories (UL) and Solar Rating and Certification Corporation (SRCC) accredited laboratory offering a complete portfolio of testing services to evaluate the performance, durability and reliability of solar cells, modules, complete arrays, concentrated solar power products and solar thermal collectors.

Atlas capabilities include test programs designed to industry standards, qualification and certification programs and proprietary R&D testing. As a global industry leader in the weathering and durability of materials, Atlas offers test services to understand the impact of long-term exposures via a global network of outdoor exposure locations. Additionally, Atlas provides material evaluations, optical properties measurements and radiometric measurements to better understand the performance of solar devices in the end-use environments.

The expansive Atlas Solar Test Center is located in the pristine Arizona desert possessing high levels of solar radiation and elevated temperatures. The site includes both indoor and outdoor testing capabilities including:

- Over 40 (16.2 ha) acres of outdoor test area to support large arrays
- Electrical grid tied capabilities for arrays of all sizes
- Fixed angle, single axis and dual axis tracking mounts
- Comprehensive state-of-the-art weather station providing solar and climatic data
- Six luminary SolarConstant steady-state simulator
- SolarClimatic chamber for temperature cycling under solar loading
- Large walk-in environmental chamber with a four luminary simulator for temperature cycling with or without solar loading for large modules
- UV pre-conditioning chambers
- Large walk-in corrosion chamber
- IV curve tracing measurements
- FLIR thermal imaging and analysis
- Electroluminescence imaging and analysis



Dual Axis Solar Tracking Rack



ATLAS 25⁺

Comprehensive
PV Durability Testing

Will My Module Last Outdoors?

This is the question most crucial to the development of a new product. Atlas 25⁺ provides the answers.

Atlas 25⁺ is a proprietary, multi-dimensional durability test program designed to subject photovoltaic modules to the environmental degradation stresses which can be expected over long-term service. It also provides a crucial missing component to the IEC type design qualification tests.



1 UV Exposure

Module A

One PV module is run through the Atlas 25⁺ testing sequence over the course of 12 months.



2 Salt Spray
Corrosion



3 Condensing
Humidity

Modules B & C

Two modules provide baseline data using outdoor solar tracking in subtropical South Florida and the Arizona Sonoran desert for one year.



Atlas 25+ – Comprehensive PV Durability Testing

- Simulates long-term environmental exposure effects
- Subjects modules to combined stresses
- Natural simultaneous exposure to solar radiation load with temperature/humidity and freeze/thaw cycles; additional corrosion and condensing humidity
- Short-term diurnal and long-term seasonal cycles closely simulate nature
- True analog of the synergistic effects of weathering in end-use conditions
- Complements short-term IEC qualification tests with long-term durability assessment to support warranty and performance claims

Atlas 25+ provides the data needed to demonstrate long-term durability and support warranty and performance claims while reducing the costs associated with aftermarket failure. Knowing how your product will hold up in the long haul is crucial to its success. Atlas 25+ will give you a clearer picture of how long your modules will last.



8 Results and Data

Completion of the Atlas 25+ program provides test data that would be otherwise unattainable with current test methods.

A report details all data, images and analyses at the end of the one year test sequence.

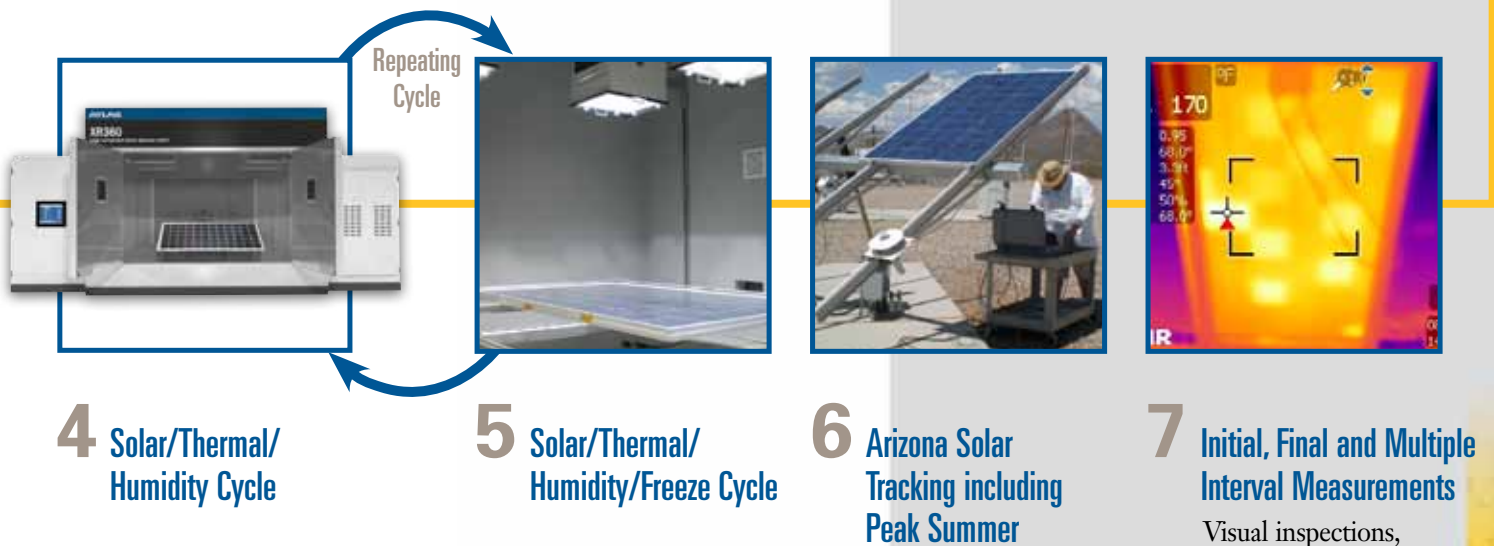

4 Solar/Thermal/
Humidity Cycle

5 Solar/Thermal/
Humidity/Freeze Cycle

6 Arizona Solar
Tracking including
Peak Summer

7 Initial, Final and Multiple
Interval Measurements

Visual inspections, IV curves, infrared thermographs and digital photography included.





A	
Atlas 25+	63-64
Automotive Exposure Testing	52-54
B	
Backed Exposures	45
BCX Basic Cyclic Corrosion Cabinet	35-38
Benchmark Exposure Sites	41-42
Black Box Exposures	45
Black Box Under Glass Exposures	46
C	
Calibration and Measurement Devices	39
CCX Advanced Cyclic Corrosion Cabinet	35-38
Ci3000+ Fade-Ometer®	11-14
Ci3000+ Weather-Ometer®	11-14
Ci4000 Weather-Ometer	11-14
Ci5000 Weather-Ometer	11-14
Color Measurement	57
Complete Vehicle Testing	54
Complete Weathering Program	3-4
Consulting Solutions	61
D	
Direct Weathering	45-46
Distinctness-of-Reflected Image (DOI)	57
E	
Emittance	58
EMMAQUA®	47-51
Evaluation Services	56-58
Exposure Sites	41-42
Exposure Racks	55
F	
Filter Combination Charts	6-8
G	
Gloss Measurement	57

H

High Speed Lighting 33

I

Indirect Weathering 46
 Instrument Comparison Charts 27-30
 Instrumental Optical Properties 56
 IP/DP Box® 52
 IR Imaging Services 56

L

Laboratory Accelerated Weathering Services 44
 Light Sources 5
 LS-200 39

M

Moisture Controlled EMMAQUA® 49-51

O

Open-Backed Exposures 45
 Outdoor Exposure Rack System 55

P

Panels and Samples 60
 Photography Services 56

R

Radiometer Measurement & Calibration 59

S

SAE J576 — Static Exposure 53
 SC340, SC600, SC1000 and SC2000
 Solar Simulation Chamber 25-26
 Scab Tests 46
 SF Salt Fog and Humidity Cabinet 35-38
 SolarConstant & High Speed Lighting 33-34
 Solar Simulation Systems 61
 Solar Test Center 62
 Specimen Holders 31-32
 Specimen Preparation & Mounting 60

Spectral Power Distribution Charts (SPDs) 9-10
 Spectrophotometry 57
 Static Exposure Testing 45-46
 SUNTEST® CPS/CPS+ 19-22
 SUNTEST XLS/XLS+ 19-22
 SUNTEST XXL/XXL+ 19-22
 Sun Tracking Carousel 54

T

Temperature Controlled EMMAQUA 49-51
 Technical Services 40
 Temperature Recording 59
 Traditional Salt Fog (Spray)
 and Humidity Cabinet 35-38
 Transmission Haze and Clarity 57

U

Ultra-Accelerated Weathering System 55
 Under Glass Exposures 46
 UVTest 23-24

V

Visual Evaluation 56

W

Walk-in Corrosion Exposure Cabinet 35-38
 Weather Station 52
 Window Energy Analysis 58
 Worldwide Exposure Network 43

X

XenoCal® 39
 Xenotest® 150 S+ 15-18
 Xenotest 220/220+ 15-18
 Xenotest Alpha+ 15-18
 Xenotest Beta+ /Beta+ FD 15-18



An **AMETEK** Company

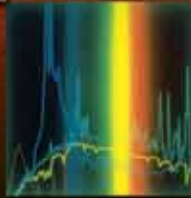
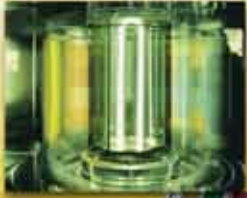

Atlas Material Testing Technology LLC
(p) +1.773.327.4520 (f) +1.773.327.5787

Atlas Material Testing Technology GmbH
(p) +49.6051.707.140 (f) +49.6051.707.149

Atlas Testing Services
(p) +1.623.465.7356 (f) +1.623.465.9409

www.atlas-mts.com

Specifications and features of products, services and the standards they meet are subject to change without notice.

©2011 Atlas Material Testing Technology LLC
All rights reserved. Printed in the USA.
Pub. No. 2066
BV Pub. No. 56352216
7.5M611T